

# Zambian Spectrometer

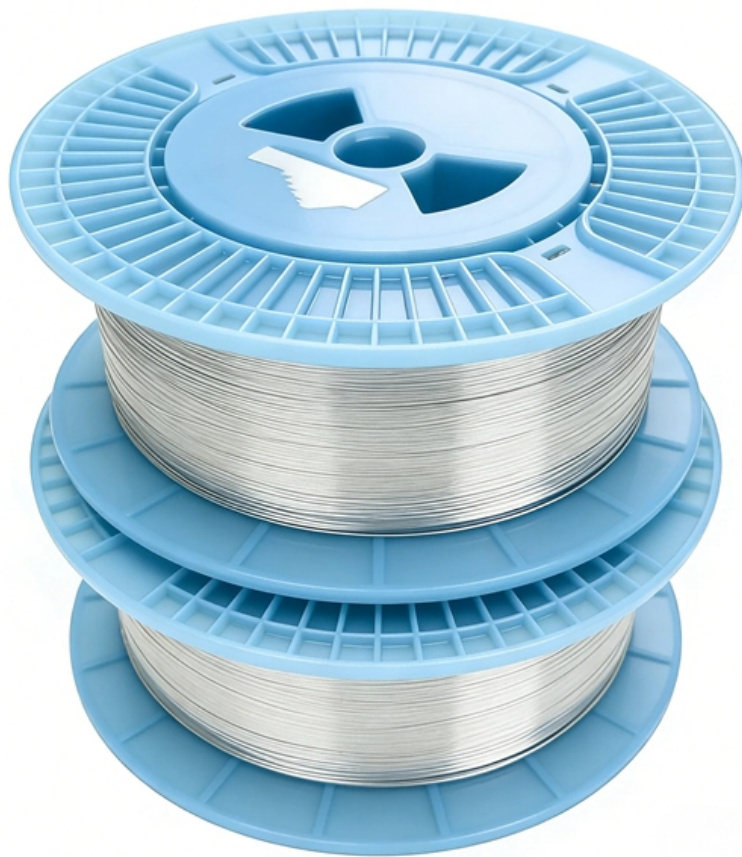



## Zambian Spectrometer

---



### **Gemological Characteristics and Trace Chemical**

This study systematically analyzed the color characteristics, microscopic inclusions (including fluid and mineral inclusions), spectral

[Contact Us](#)

### **Buy Mass Spectrometers in Zambia , Franance Health Systems**

When selecting a mass spectrometer supplier in Zambia, reliability, expertise, and ongoing support are paramount. Franance Health stands out as a trusted partner, ensuring you receive not only cutting

[Contact Us](#)

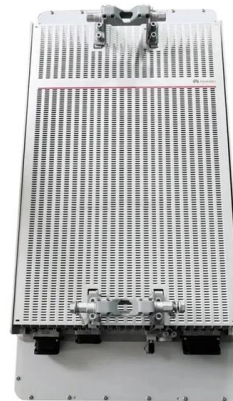

### **mass spectrometers Manufacturers serving Zambia**

List of mass spectrometers Manufacturers serving Zambia Hiden - Model RGA Series - Mass Spectrometers for Residual Gas Analysis Systems for the examination of components present in a

[Contact Us](#)



### **atomic absorption aa spectrometers Companies serving Zambia**

List of atomic absorption aa spectrometers companies, manufacturers and suppliers serving Zambia

[Contact Us](#)



### laboratory spectrometer Companies and Suppliers serving

List of laboratory spectrometer companies, manufacturers and suppliers serving Zambia

[Contact Us](#)

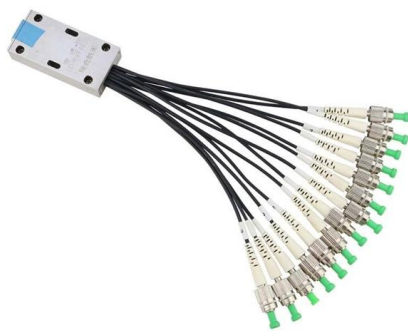

### Trace gas emissions from the production and use of

Therefore, as part of SAFARI 2000, we used open-path Fourier transform infrared (OP-FTIR) spectroscopy to measure the trace gases emitted

[Contact Us](#)

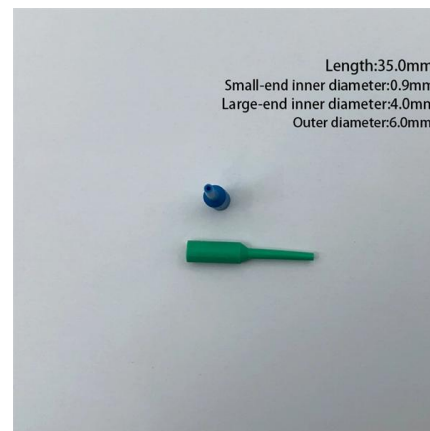

### Mass-Spectrometers Companies And Suppliers Serving Zambia ,

List of mass-spectrometers companies, manufacturers and suppliers serving Zambia

[Contact Us](#)





## Distinguishing African bovids using Zooarchaeology by

Distinguishing African bovids using Zooarchaeology by Mass Spectrometry (ZooMS): New peptide markers and insights into Iron Age

[Contact Us](#)

Mechanical drawing

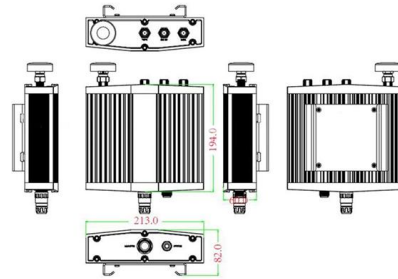

## James Ilunga Katende

Am a metallurgical engineer, proficient in general metal processing and beneficiation · Experience: Spectrometer Technologies · Education: The Copperbelt University · Location: Lusaka Province ·

[Contact Us](#)

## icp spectrometer Companies and Suppliers serving Zambia ,

List of icp spectrometer companies, manufacturers and suppliers serving Zambia

[Contact Us](#)



## An Analysis of Substandard Propofol Detected in Use in

BACKGROUND: In early 2015, clinicians throughout Zambia noted a range of unpredictable adverse events after the administration of propofol, including

[Contact Us](#)



## Fiber Optic Spectrometers Suppliers Serving Zambia

Find the top fiber optic spectrometers suppliers & manufacturers serving Zambia from a list including Galaxy Scientific Inc, Avantes BV & SIMTRUM Pte. Ltd.

[Contact Us](#)

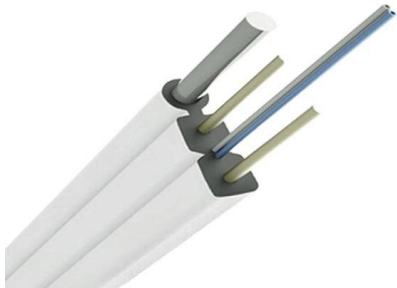

## Spectrophotometer Manufacturers In Zambia, Exporters

We are a pioneer Spectrophotometer Exporters and Suppliers in Zambia. Our dedicated customer support team is always available to assist with any inquiries, providing a seamless experience from

[Contact Us](#)

## Zambia Spectrometer Market (2025-2031) , Industry & Outlook Growth

Zambia Spectrometer Market shows significant regional demand variations, driven by diverse applications in agriculture, mining, and environmental monitoring.

[Contact Us](#)



## Visible Spectrophotometer In Zambia

We stand amidst the trusted Visible Spectrophotometer manufacturers in Zambia, ensuring precision, durability, and performance. Our state-of-the-art manufacturing facilities are equipped with the latest

[Contact Us](#)



### mass spectrometers Manufacturers serving Zambia ,

List of mass spectrometers Manufacturers serving Zambia Hiden - Model RGA Series - Mass Spectrometers for Residual Gas Analysis Systems for the examination of components present in a

[Contact Us](#)



### uv vis spectrometers Companies serving Zambia

List of uv vis spectrometers companies, manufacturers and suppliers serving Zambia

[Contact Us](#)

### Uv Vis Spectrometers Manufacturers Serving Zambia ,

Enhanced Spectrometry, Inc has started the commercial activities with the mission to bring innovative development in the field of Raman and Luminescence spectroscopy to people worldwide. The company



[Contact Us](#)



### Spectrometer In Zambia

Today, we have our name renowned among the trusted Spectrometer Manufacturers in Zambia. Our products are easy to browse and available in different customizations that give clients value for their

[Contact Us](#)



## spectrometers Companies and Suppliers in Zambia ,

contrAA - Model 800 D - Atomic Absorption Spectrometer AAS for flame, graphite furnace, and hydride techniques. This flexible all-rounder has an automatic atomizer that changes for use with flame,

[Contact Us](#)



## Zambia Spectrometers Buyers and Importers List!

Explore active Spectrometers buyers in Zambia looking for reliable suppliers. Get direct trade leads from importers, buyers, and distributors on Tradewheel .

[Contact Us](#)

## Spectrophotometer In Zambia , Spectrophotometer Manufacturers

We stand amidst the trusted Spectrophotometer manufacturers in Zambia, ensuring precision, durability, and performance. Our state-of-the-art manufacturing facilities are equipped with the latest technology

[Contact Us](#)



IP65/IP55 OUTDOOR CABINET

OUTDOOR CABINET WITH AIR CONDITIONER

OUTDOOR ENERGY STORAGE CABINET

19 INCH



## Zambia Spectrophotometer Market (2025-2031) , Size & Forecast

6Wresearch actively monitors the Zambia Spectrophotometer Market and publishes its comprehensive annual report, highlighting emerging trends, growth drivers, revenue analysis, and forecast outlook.

[Contact Us](#)



### atomic absorption spectrophotometers Companies serving Zambia

List of atomic absorption spectrophotometers companies, manufacturers and suppliers serving Zambia

[Contact Us](#)

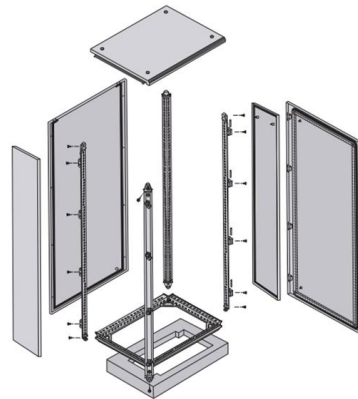

### ftir spectrometers Companies and Suppliers serving Zambia ,

KASSAY is a supplier of specialized FTIR field spectrometers used for vapor leak detection, analysis of toxic gas plumes, and ambient air monitoring of greenhouse gas. FTIR instruments can be

[Contact Us](#)

### Spectrometer Technologies will be

Spectrometer Technologies will be exhibiting at ZIMEC 2023 in Zambia from November 1st to November 2nd. Here's what you need to know: ->Spectrometer Technologies is a company that markets a

[Contact Us](#)



### Spectrometer Student Manufacturer and Supplier in

Spectrometer Student Manufacturer in Zambia Specification: The base, integral with the collimator tube support, carries the swinging telescope arm pivoted on a

[Contact Us](#)

### Spectrometer Imports into ZAMBIA



Gain access to ZAMBIA's Spectrometer imports data, including information on top suppliers, top buyers, and shipment details such as quantity, price, HSN code and Trading partners

[Contact Us](#)



### **emission spectrometers Companies and Suppliers serving**

Hitachi High-Tech - Model OE series - Stationary Optical Emission Spectrometers These ground-breaking spectrometers OE720 and OE750 offer high optical resolution and low detection limits.

[Contact Us](#)

## **Contact Us**

---

For datasheets, pricing, or custom fiber access solutions, please visit:  
<https://www.frindel.es>