

Yemen Waterproof Optical Cable





Yemen Waterproof Optical Cable



Under Construction Optical Fiber Cables Factory

The product includes: optical fiber, loose tube, fiber compound, cable core, strengthened steel wire, water blocking tape, steel-composite belt, sheath with Kevlar.

[Contact Us](#)

Are the global underwater communication cables the

Over 800,000 kilometers of underwater communication cables are laid on seabeds around the world, ensuring the ability of the world's citizens to

[Contact Us](#)

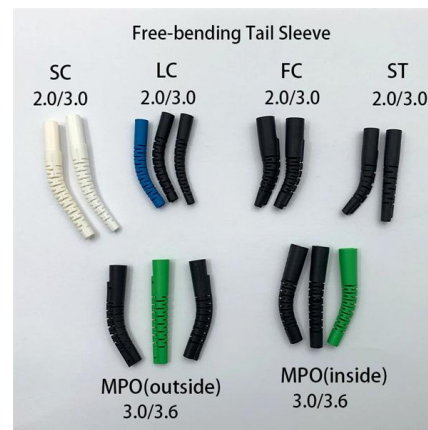

Red Sea cables are cut, disrupting internet in Asia and

DUBAI, United Arab Emirates (AP) -- Undersea cable cuts in the Red Sea disrupted internet access in parts of Asia and the Middle East, experts said

[Contact Us](#)

Yemen Fibre Optic Cable Market (2025-2031) , Trends, Outlook

6Wresearch actively monitors the Yemen Fibre Optic Cable Market and publishes its comprehensive annual report, highlighting emerging trends, growth drivers, revenue analysis, and forecast outlook.



Yemen Active Optical Cables Market (2025-2031) , Trends, Outlook

6Wresearch actively monitors the Yemen Active Optical Cables Market and publishes its comprehensive annual report, highlighting emerging trends, growth drivers, revenue analysis, and forecast outlook.

[Contact Us](#)



Full Repairs to Damaged Red Sea Internet Cables Delayed by Yemen

Full repairs to three submarine internet cables damaged in the Red Sea in February are being held up by disputes over who controls access to infrastructure in Yemeni waters.

[Contact Us](#)



Yemen Fiber Optic Cables Market (2025-2031) , Revenue & Outlook

6Wresearch actively monitors the Yemen Fiber Optic Cables Market and publishes its comprehensive annual report, highlighting emerging trends, growth drivers, revenue analysis, and forecast outlook.

[Contact Us](#)





Waterproof optical cable, Watertight optical cable

Find your waterproof optical cable easily amongst the 42 products from the leading brands (HUBER+SUHNER, Motec, YOFC,) on DirectIndustry, the industry specialist for your professional

[Contact Us](#)



Man Telecom Solutions

MTS is proud to be an industry leader in the design, supply, installation and maintenance of telecommunications, IT and power equipment, surveillance and security systems and solar/hybrid

[Contact Us](#)

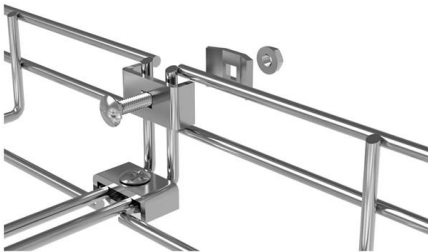

Wholesale Yemen Cable Direct Burial Underground Cable , Alibaba

Yemen cables are specifically engineered to withstand some of the most demanding climatic and operational conditions in the world. Built with high-performance materials and advanced

[Contact Us](#)



Rubymar sinking: Did Houthi ship attack sever Red Sea

Following the Houthi attack on British-owned vessel Rubymar off the coast of Yemen, three internet cables were cut.

[Contact Us](#)



Cut Undersea Cable Plunges Yemen Into Days-Long

Cut Undersea Cable Plunges Yemen Into Days-Long Internet Outage The fragility of global internet infrastructure has left the entire Red Sea region

[Contact Us](#)

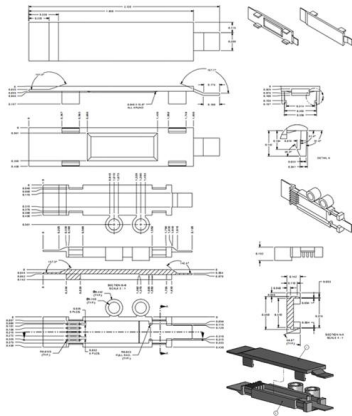

Yemeni telecommunications ministry issues statement on submarine cables

The Ministry of Telecommunications and Information Technology in the Sana'a government on Tuesday denied the truthiness of what was being promoted by media outlets affiliated

[Contact Us](#)

Yemen optical fibre cables tenders and Bids

Get access to latest Yemen optical fibre cables tenders and government contracts. Find business opportunities for Yemen optical fibre cable tenders, Yemen optical fibre accessories tenders.

[Contact Us](#)

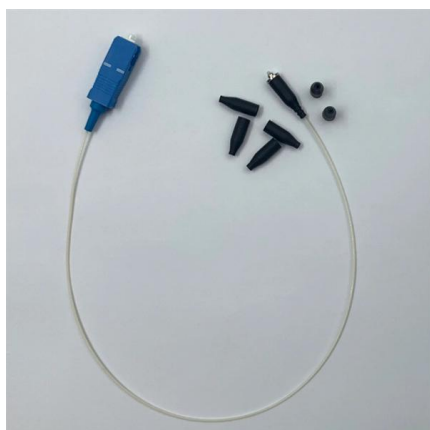

Yemen Undersea Fiber-Optic Cable Cuts , Factually

A series of undersea fiber-optic cable cuts near Yemen have caused regional latency spikes and service outages, highlighting the fragility of global data arteries and the cascading

[Contact Us](#)



Pigtail Multifiber Optic Cables 6 Strand Fiber St Upc Singlemode

These 6 fiber pigtails with 900-micron buffer are ready for splicing. Each fiber strand in the kit has a color-coded buffer for easy identification and the colors are the industry standard. In this 6-pack,

[Contact Us](#)



Yemen Active Optical Cables Market (2025-2031) , Trends, Outlook

6Wresearch actively monitors the Yemen Active Optical Cables Market and publishes its comprehensive annual report, highlighting emerging trends, growth drivers, revenue analysis, and forecast outlook.

[Contact Us](#)

Fiber optic network systems for data transmission

We provide a wide range of high-performance fiber optic cables designed to deliver high data transmission speeds and exceptional stability. Our services include: Fiber Optic Cable Installation:

[Contact Us](#)

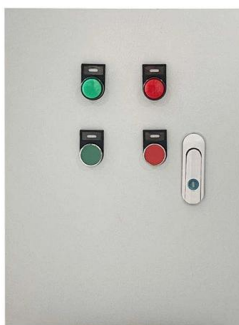
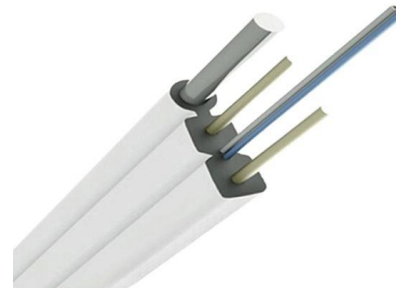

Yemen Fiber Optic Cable Market (2024-2030) , Trends, Outlook

Yemen Fiber Optic Cable Market is expected to grow during 2025-2031

[Contact Us](#)



Telecommunications in Yemen

Yemen is a landing point for the international submarine cable Fiber-Optic Link Around the Globe (FLAG). In 2005 TeleYemen announced it would invest in the FALCON high-capacity loop cable

[Contact Us](#)

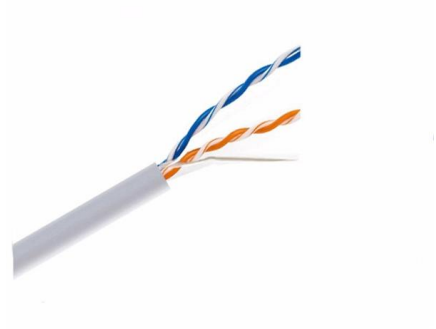

Red Sea Internet Cables 'Cut' -- Here's What We Know

Topline At least four undersea fiber optic cables, which carry approximately 97% of all Internet traffic, were damaged last week in the Red Sea,

[Contact Us](#)

Yemen Optical Fibre Tenders, Bids & RFPs 2026

Latest Yemen Optical Fibre Tenders, Government Bids, RFP and other public procurement notices related to Optical Fibre from Yemen. Users can register and get updated information on Yemen

[Contact Us](#)



WINSOME Black Electrical Tape 10 Rolls Waterproof Heat Resistant

Shop WINSOME Black Electrical Tape 10 Rolls Waterproof Heat Resistant Tape 20m x 19mm - Strong Heavy Duty, Sticky, PVC Electric Insulation Tape for Wires, and Cables , Pack of 10 online at best

[Contact Us](#)



GJA Waterproof Fiber Optic Cable

GJA waterproof pigtail cable use simplex cable (?900um tight buffer fiber, around

[Contact Us](#)



The Next Casualty of the Red Sea Attacks: Undersea

The image was accompanied by an ominous message: "There are maps of international cables connecting all regions of the world through the sea.

[Contact Us](#)

Waterproof Cables: Secure Connections in Any Weather

Waterproof Fiber Optic Cable Built to ensure reliable and high-speed data transmission in wet or harsh environments, this cable is commonly used in

[Contact Us](#)



Yemen Fiber Optic Cable Market 2023-2030

An assembly comparable to an electrical cable but incorporating one or more optical fibres that are used to convey light is referred to as a fiber-optic cable, also known as an optical-fiber cable.

[Contact Us](#)



3 Red Sea data cables cut as Houthis launch more

Three cables under the Red Sea that provide global internet and telecommunications have been cut as the waterway remains a target of Yemen's

[Contact Us](#)

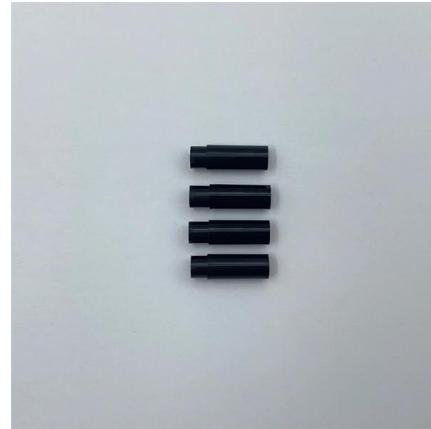

Contact Us

For datasheets, pricing, or custom fiber access solutions, please visit:
<https://www.frindel.es>