

# **Western European Intelligent Power Distribution Cabinet Configuration**

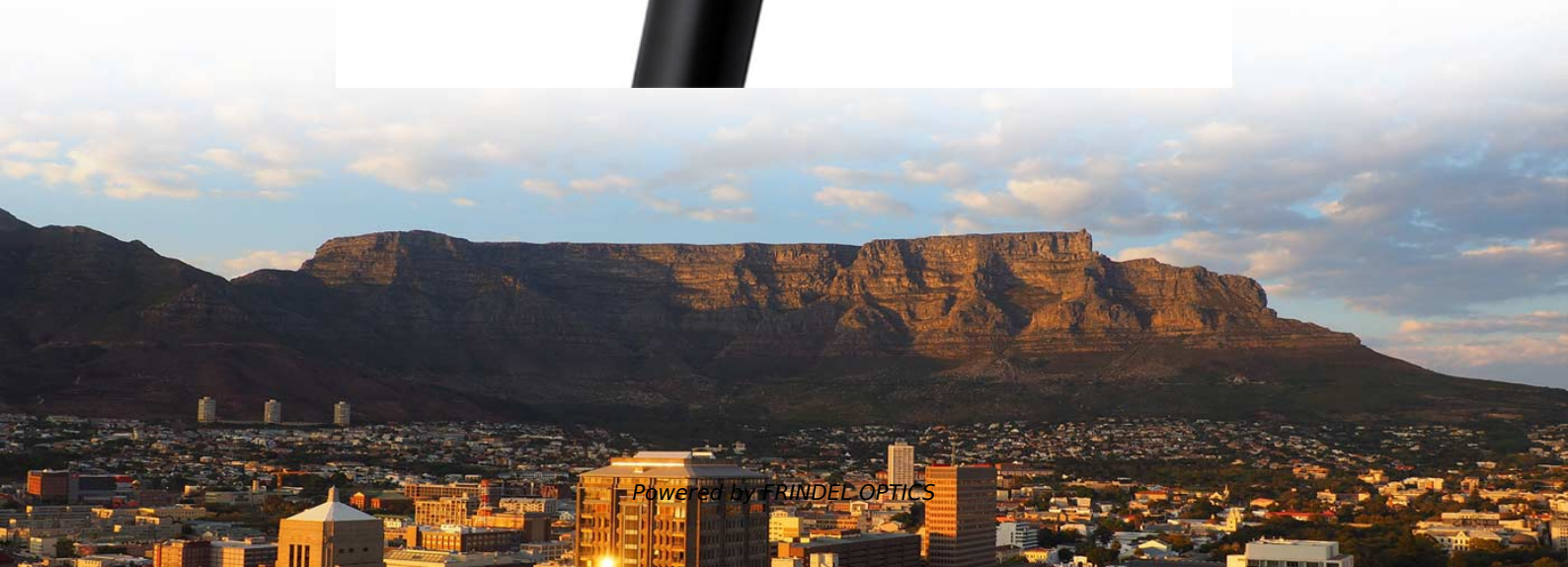



## Western European Intelligent Power Distribution Cabinet Configuration

---



IP65 / IP67 Sealing Design



Reserved Bottom Mounting Holes

### White Paper

Intelligent power distribution units deployed at the cabinet level in a data center provide data and control for the data center operator. Utilizing DCIM tools to automate PDU configuration, perform data

[Contact Us](#)

### iPower Intelligent Power Distribution Units

EDP iPower, from EDP Europe, is a range of intelligent power distribution units (PDUs) that are manufactured and supported in the UK. With today's ever

[Contact Us](#)



### Energix-P40 Power Distribution Cabinet

Energix-P40 Power Distribution Cabinet As a power distribution unit, PDU provides stable and reliable power to IT racks on the outgoing side and is widely used in data centers. The product has the

[Contact Us](#)

### IPDM Intelligent Precision Cabinet - iTeaQ

Flexible Power Distribution System IPDM intelligent precision cabinet is composed of the power distribution system, lightning arrester, computer-grade grounding compartment, and power



### **RackPower Intelligent Power Distribution Units**

RackPower Intelligent Power Distribution Units address controlling power on Cabinets as well as Open Frame Racks and Wall-Mount enclosures. Design your

[Contact Us](#)



### **Transformation and Application of Traditional Low Voltage Distribution**

The main components of the traditional GGD low-voltage distribution cabinet are fixed products, the equipment runs in isolation, does not have the communication function, and is unable to carry

[Contact Us](#)



### **Power Distribution Power distribution systems**

This white paper looks at how to improve power supply reliability and safety, including the dangers of arc flash and how to mitigate against it through careful power system design and the benefits of power

[Contact Us](#)





## Intelligent precision power distribution system

It is not just a distribution Cabinet, power inputs, outputs, power monitoring system as a whole set of integrated power distribution design, is future-oriented distribution system. In addition to distribution

[Contact Us](#)



## ALPHA 3200 power distribution boards

The SIMARIS configuration software provides support for rapid configuration of your distribution systems, from enclosure to components, from power distribution to distribution boards, and from

[Contact Us](#)

## Intelligent Power Distribution Cabinet with Advanced PLC Control

Intelligent Power Distribution Cabinet with Advanced PLC Control System, Find Details and Price about Power Distribution Cabinet LED Power Distribution Cabinet from Intelligent Power

[Contact Us](#)



## Remote Management of Data Center Cabinets

Those responsible for remotely located ICT equipment or a laboratory environment stand to benefit from remote power control. Intelligent rack power distribution units (PDUs) with remote power control

[Contact Us](#)



### Power Distribution Cabinets: Centralized Solutions for

Explore the critical role of Power Distribution Cabinets (PDCs) in modern electrical systems. Learn about their evolution, centralized power

[Contact Us](#)

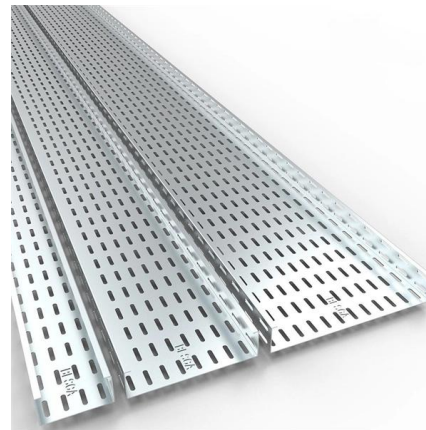

### Intelligent Power Distribution Units

Our intelligent power distribution units are held to the highest quality standards due to our rigorous testing, adherence to standardized production methods, and comprehensive quality management

[Contact Us](#)

### SOETECK Precision Power Distribution Cabinet with

The SOETECK Precision Power Distribution Cabinet with Hot-Swappable Design offers a comprehensive power management solution that supports stable and

[Contact Us](#)

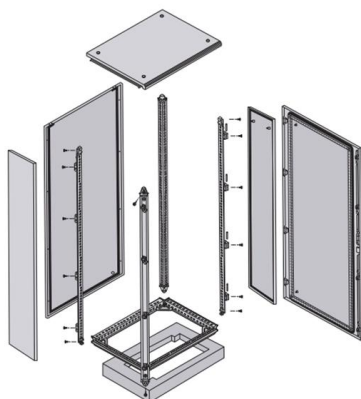

### EL2P Intelligent Power Distribution Unit

Managing and installing a rack power distribution unit (PDU) has never been easier than with the EL2P PDU. Designed to simplify deployment and take stress out of

[Contact Us](#)

### DTU Intelligent Electrical Control Cabinet ,



## Power Distribution

Wonder DTU Intelligent Electrical Cabinet enables automated power distribution with real-time monitoring, remote control, and fault protection. Ideal for smart grids, renewables, and industrial

[Contact Us](#)



## Design of New-Type Power Distribution Cabinets

Explore innovative design strategies for HV/LV power distribution cabinets and boxes, focusing on safety, reliability, smart control, structural optimization, and

[Contact Us](#)

## Smart power distribution solutions

There are cabinet variants for both overhead line and underground cable networks. The cabinets are suitable for all applications, ranging from basic monitoring functionality to more advanced solutions

[Contact Us](#)



## Liebert RDC Remote Distribution Cabinet User Manual

User manual for Liebert RDC Remote Distribution Cabinet: installation, operation, maintenance, and safety instructions.

[Contact Us](#)



## RackPower Intelligent Power Distribution Units

RackPower Intelligent Power Distribution Units  
RackPower Intelligent Power Distribution Units address controlling power on Cabinets as well as Open Frame

[Contact Us](#)

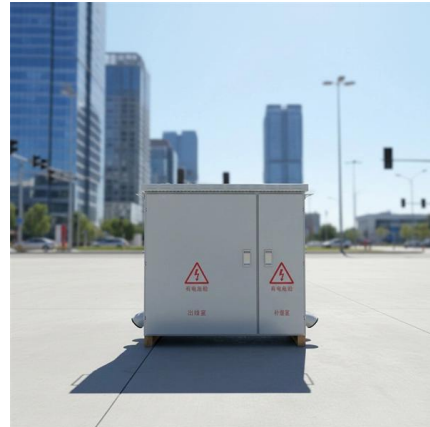

## Design of Intelligent Power Distribution Cabinet Based on Intelligent

Based on the current status of the development of power distribution cabinet, as well as the current intelligent power network technology and intelligent equipm

[Contact Us](#)



## Transformation and Application of Traditional Low

The main components of the traditional GGD low-voltage distribution cabinet are fixed products, the equipment runs in isolation, does not have the

[Contact Us](#)



## RackPower Intelligent Power Distribution Units , nVent HOFFMAN

RackPower Intelligent Power Distribution Units address controlling power on Cabinets as well as Open Frame Racks and Wall-Mount enclosures. Design your power solution using a variety of

[Contact Us](#)





## Design of Intelligent Power Distribution Cabinet Based on Intelligent

Download Citation , On Oct 1, 2021, Xian Wang published Design of Intelligent Power Distribution Cabinet Based on Intelligent Distribution Network , Find, read and cite all the research you need

[Contact Us](#)



## The Power Quality Monitoring Method of Intelligent Power Distribution

To improve the authenticity of reconstructed signals in power quality disturbance detection, an improved wavelet denoising method based on a coquantum-particle swarm is proposed to solve

[Contact Us](#)

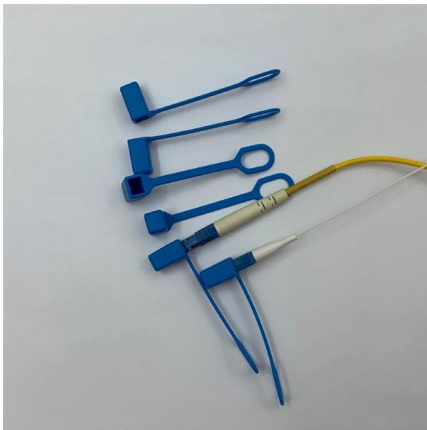

## Smart control cabinets Solutions for automating the secondary

The range of control cabinets for cable networks comes in different sizes and materials and can be flexibly mounted to suit a variety of installations, whereas the cabinets for overhead-line networks

[Contact Us](#)



## Smart control cabinets Solutions for automating the secondary

-- 02 Pole-mounted control cabinet connected to an overhead-line recloser -- 01 et today's diverse and evolving customer requirements within power distribution. The ready-made solutions offer a cost

[Contact Us](#)

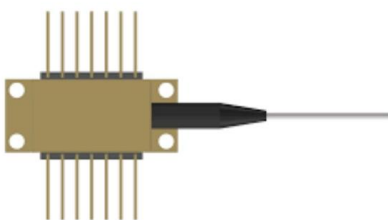



## Planning of Electric Power Distribution

The first volume in our series "Planning of Electric Power Distribution - Technical Principles", focused on general requirements and characteristics of relevance to planning electric power distribution systems.

[Contact Us](#)

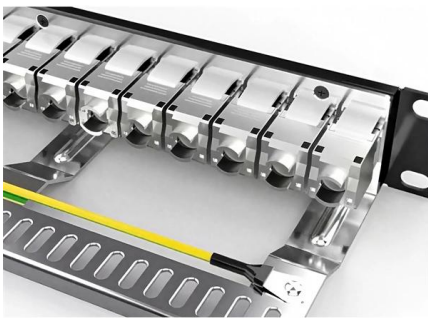

## Planning of Electric Power Distribution

To this end, we are launching a new series, whereby volume 2 will consist of several individual modules. This newly designed first volume, "Planning of Electric Power Distribution - Technical Principles",

[Contact Us](#)

## Contact Us

---

For datasheets, pricing, or custom fiber access solutions, please visit:  
<https://www.frindel.es>