

Sudan sells laser diodes





Sudan sells laser diodes



Laser Diode Manufacturers & Suppliers , ProPhotonix

High quality laser diode manufacturers including brands like Osram, Ushio, QSI and Ondax. Click to discover more.

[Contact Us](#)

Sudan Solid and Diode Medical Laser Market (2024-2030) , Share

Sudan Solid and Diode Medical Laser Industry Life Cycle Historical Data and Forecast of Sudan Solid and Diode Medical Laser Market Revenues & Volume By Product Type for the Period 2020-2030

[Contact Us](#)



Lasers, Other Than Laser Diodes

Statistics illustrates consumption, production, prices, and trade of Lasers, Other Than Laser Diodes in Sudan from 2007 to 2024.

[Contact Us](#)



Laser Diode Market Size, Forecast Report, Competitive Landscape 2031

Growing demand for 800-gigabit and 1.6-terabit optical links in hyperscale data centers, the integration of solid-state LiDAR in production vehicles, and defense funding for diode-pumped

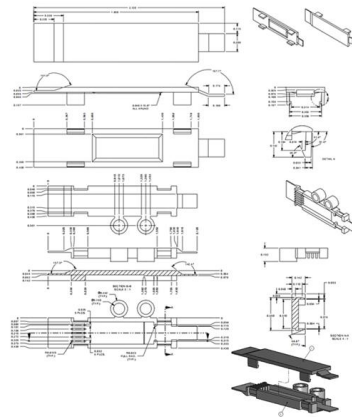

tunable-diode-lasers Companies and Suppliers near Sudan ,

Protea - Model TDLAS - Tunable Diode Laser Absorption Spectroscopy For highly selective gas measurements of one or two gases, TunableDiodeLaser Absorption Spectroscopy (TDLAS) has

[Contact Us](#)



Laser Diodes Market Report Size, price, Share Analysis 2032

The development of advanced materials in material science can lead to the development of new laser diodes with improved performance and functionalities, and the growing focus on sustainability can

[Contact Us](#)



Sudan-diode laser (@sudan_diode_laser)

101 Followers, 224 Following, 98 Posts - See Instagram photos and videos from Sudan-diode laser (@sudan_diode_laser)

[Contact Us](#)





Sudan Semiconductor Diode Market (2024-2030) , Trends, Share,

Historical Data and Forecast of Sudan Semiconductor Diode Market Revenues & Volume By Computer & Computer Peripherals for the Period 2020- 2030 Sudan Semiconductor Diode Import Export Trade

[Contact Us](#)



South Sudan Lasers Quantum Dots Market (2024-2030) , Share,

Historical Data and Forecast of South Sudan Lasers Quantum Dots Market Revenues & Volume By Distributed Bragg Reflector Laser Diodes (DBR) for the Period 2020- 2030

[Contact Us](#)

Sudan Laser Diode Market (2025-2031) , Share & Size

6Wresearch actively monitors the Sudan Laser Diode Market and publishes its comprehensive annual report, highlighting emerging trends, growth drivers, revenue analysis, and forecast outlook. Our

[Contact Us](#)

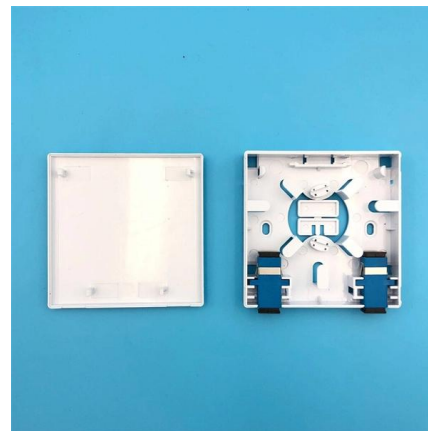

South Sudan Light Emitting Diodes Market (2025-2031) , Competition

South Sudan Light Emitting Diodes Industry Life Cycle Historical Data and Forecast of South Sudan Light Emitting Diodes Market Revenues & Volume By Product Type for the Period 2021-2031

[Contact Us](#)



Laser Diode Market Size and Outlook Report 2026 to 2035

Major companies operating in the laser diode market are focusing on developing advanced pump laser diode technologies to improve output power, energy

[Contact Us](#)



Sudan Semiconductor Diodes Market (2024-2030) , Trends, Outlook

Sudan Semiconductor Diodes Market is expected to grow during 2024-2030

[Contact Us](#)

By 2032, Laser Diode Market Size, Share, Trends and

The global Laser Diode Market, 2032 size, analysis, trends, & forecasts. The global market for laser diode market categorized by Wavelength,

[Contact Us](#)

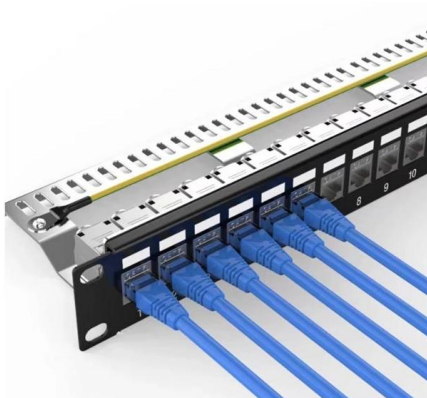

tunable diode lasers Companies and Suppliers near Sudan ,

Protea - Model TDLAS - Tunable Diode Laser Absorption Spectroscopy For highly selective gas measurements of one or two gases, TunableDiodeLaser Absorption Spectroscopy (TDLAS) has

[Contact Us](#)

Sudan's Diode Market Report 2025



In 2024, the Sudanese diode market decreased by -19.6% to \$80M for the first time since 2019, thus ending a four-year rising trend. Over the period under review, consumption showed a

[Contact Us](#)

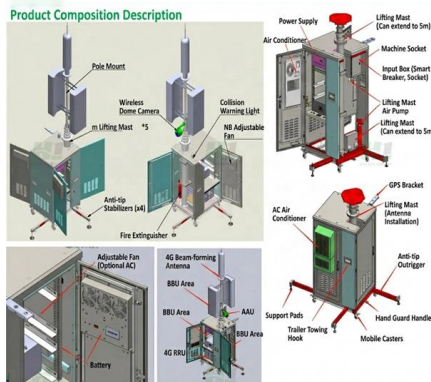
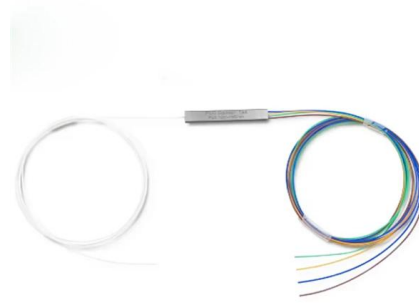

Sudan Two Terminal Laser Diode Market (2025-2031) , Companies

Sudan Two Terminal Laser Diode Industry Life Cycle Historical Data and Forecast of Sudan Two Terminal Laser Diode Market Revenues & Volume By Type for the Period 2020- 2030

[Contact Us](#)

Sudan Lasers Market (2024-2030) , Trends, Outlook & Forecast

Historical Data and Forecast of Sudan Lasers Market Revenues & Volume By Fiber Lasers for the Period 2020-2030 Historical Data and Forecast of Sudan Lasers Market Revenues & Volume By

[Contact Us](#)



Sudan

For the eighth year in a row, Sudan recorded growth in overseas shipments of lasers, other than laser diodes, which increased by X% to X units in 2022. Overall, exports showed a

[Contact Us](#)





Sudan Diodes Market (2024-2030) , Outlook, Analysis, Trends, Size

How does 6W market outlook report help businesses in making decisions? 6W monitors the market across 60+ countries Globally, publishing an annual market outlook report that analyses trends, key

[Contact Us](#)

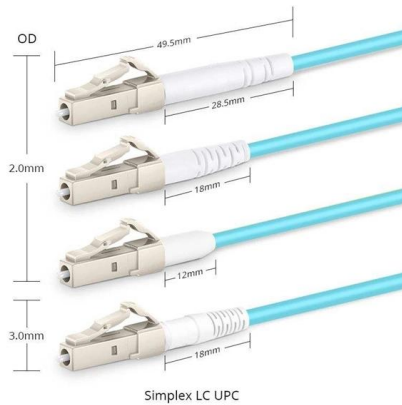

Sudan , Imports and Exports , World , Diodes, transistors and similar

Top export destinations of "Semiconductor devices (e.g. diodes, transistors, semiconductor based transducers); including photovoltaic cells assembled or not in modules or panels, light-emitting

[Contact Us](#)

Laser Diode Market Size, Share & Trend & Analysis

Laser diode market size was valued at USD 7.7 billion in 2024 and is estimated to register a CAGR of 14.4% between 2025 and 2034, driven by growing demand

[Contact Us](#)



Sudan Green Laser Diode Market (2025-2031) , Trends, Outlook

Market Forecast By Type (Direct Emission, Frequency Doubled, External Cavity), By Wavelength (510-530 nm, 532 nm, 515 nm), By Application (Industrial Lasers, Biomedical, Display Technology), By

[Contact Us](#)



South Sudan Laser Diode Controller Market (2024-2030) , Industry

South Sudan Laser Diode Controller Industry Life Cycle Historical Data and Forecast of South Sudan Laser Diode Controller Market Revenues & Volume By Type for the Period 2020- 2030

[Contact Us](#)

Mesh door/glass door optional



Sp-601 glass door

Sp-602 mesh door



Laser Diode Market Size, Forecast Report, Competitive

Laser Diode Market Size & Share Analysis - Growth Trends and Forecast (2026 - 2031) The Laser Diode Market Report is Segmented by Type

[Contact Us](#)

Sudan Ophthalmology Lasers Market (2024

Sudan Ophthalmology Lasers Market is expected to grow during 2023-2029

[Contact Us](#)

High Quality Aluminum Housing with Compact Size

- Sturdy and Durable
- Anti-corrosion

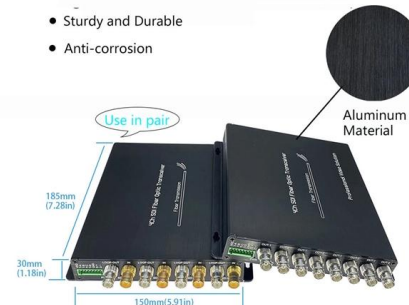

Laser Diode Market Size, Forecast Report, Competitive

Growing demand for 800-gigabit and 1.6-terabit optical links in hyperscale data centers, the integration of solid-state LiDAR in production

[Contact Us](#)



Sudan Laser for Semiconductor Market (2025-2031) , Growth

Sudan Laser for Semiconductor Market is expected to grow during 2025-2031

[Contact Us](#)



47 Laser Diode Manufacturers in 2026

This section provides an overview for laser diodes as well as their applications and principles. Also, please take a look at the list of 47 laser diode manufacturers and

[Contact Us](#)

The latest products for diode lasers in 2024 , Electro Optics

The ability of diode lasers to convert electrical energy directly into laser light has led them to become an increasingly popular choice in a number of industries and applications, where. They may provide a

[Contact Us](#)

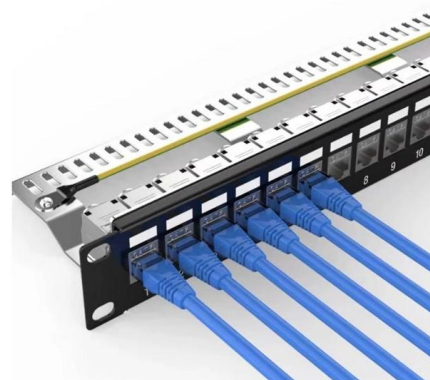

South Sudan Green Laser Diode Market (2025-2031) , Drivers

6Wresearch actively monitors the South Sudan Green Laser Diode Market and publishes its comprehensive annual report, highlighting emerging trends, growth drivers, revenue analysis, and

[Contact Us](#)



Contact Us

For datasheets, pricing, or custom fiber access solutions, please visit:
<https://www.frindel.es>