

# Singapore SFP Optical Module 40G





## Overview

---

The SULITON Transceiver module 40G is an enhanced QSFP28 fiber optic transceiver supporting transmission at 40 Gb/s up to 150m over OM4 multimode fiber (MMF) using a wavelength of 850nm via MTP/MPO-12 connector. The Cisco ® 40GBASE QSFP (Quad Small Form-Factor Pluggable) portfolio offers customers a wide variety of high-density and low-power 40 Gigabit Ethernet connectivity options for data center, high-performance computing networks, enterprise core and distribution layers, and service provider. Juniper's 40G and 4 x 10G optical transceivers are well suited for performance-critical deployments in cloud and enterprise networks. QSFP+ modules are compatible with various technologies, including Ethernet, InfiniBand and.



## Singapore SFP Optical Module 40G

---



### small form factor pluggable module 40G

The SFP Transceiver 40G provides an excellent solution for high reliability, lower power consumption and excellent EMI performance allow system design with high port density. This product is RoHS

[Contact Us](#)

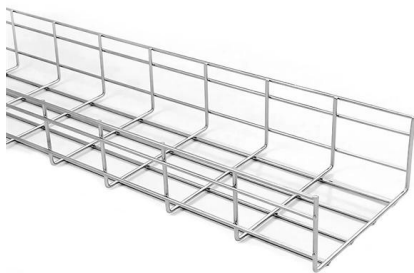

### 40G QSFP+ Transceiver Modules

We provide a full range of 40G QSFP+ optical transceivers, including SR4, SR BIDI, SWDM4, IR4, LR4, LX4, PSM IR4, PSM LR4, ER4, ZR4. They adopt the optical cables with LC or MPO connectors.

### VIAVI Solutions , Network Test, Monitoring, and Assurance

Our test, monitoring, assurance, and resilient position, navigation and timing solutions enable and secure critical infrastructure ranging from data center

[Contact Us](#)

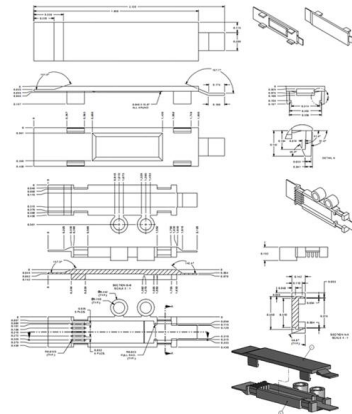

### 40Gbps QSFP+ Optical Modules

40Gbps QSFP+ Optical Modules QSFP-40G-LR4  
QSFP-40G-SDLC-PAM QSFP-40G-SR-BD  
(O2311FPA) QSFP-40G-eSR4 QSFP-40G-iSR4  
QSFP-40G-LX4 QSFP-40G-ER4 QSFP-40G-LR4

[Contact Us](#)

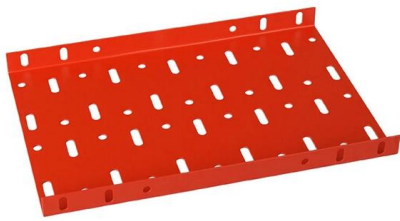

### 40G QSFP+ Optical Transceiver Module(id:11667944) Product details

40G QSFP+ Optical Transceiver Module(id:11667944), View quality 40G QSFP+, OPTICAL TRANSCEIVER, SFP MODULE details from III-V Technology Shenzhen Co., Ltd storefront on

[Contact Us](#)

### SFP vs QSFP: Which Module Does Your Switch Need? (2025 Guide)

Struggling to choose between SFP and QSFP? Compare speed, density, and cabling costs side-by-side. Discover the best use cases for SFP vs QSFP.

[Contact Us](#)



### QSFP+ 40G

With data transmission speeds of up to 40 Gbps, these compact modules are ideal for data center deployments and high-speed applications. QSFP+ modules are compatible with various

[Contact Us](#)



### Cisco 40GBASE QSFP Modules Data Sheet

This module can be used for native 40G optical links over 12-fiber ribbon cables with MPO/MTP connectors or in 4x10G mode with parallel-to-duplex fiber breakout cables for connectivity

[Contact Us](#)

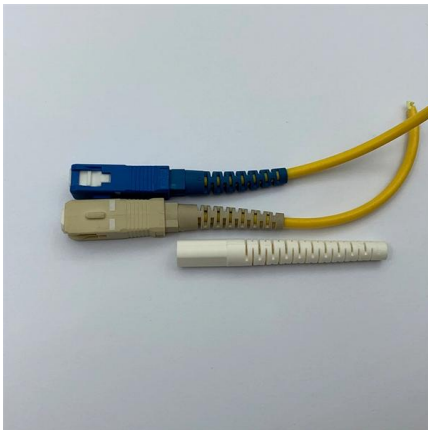
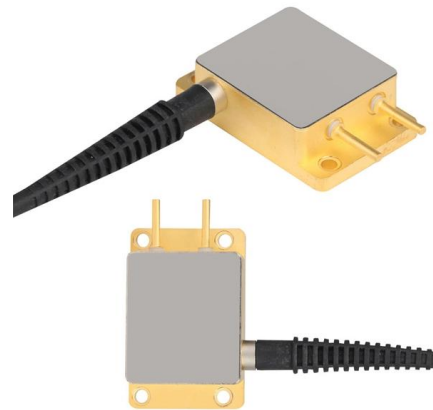

### Pluggable Optical Module Market Research Report 2034

The pluggable optical module market was valued at \$9.8 billion in 2025 and is projected to reach \$26.4 billion by 2034, growing at a CAGR of 11.6%.

[Contact Us](#)

### Juniper 40G Optical Transceiver (Silver) , High-Speed 40Gbps SFP+

Shop Juniper 40G Optical Transceivers (Silver) in Singapore. Buy SFP+ and QSFP+ modules for 40Gbps high-speed network connections in data centers, enterprises, and service providers.

[Contact Us](#)



### 40G QSFP+ Transceiver Modules , Optical Transceivers

FS 40G QSFP+ optical transceiver module solutions offer a full range of QSFP+ modules from 150m to 80km reach, and used for high-density switching, routing and data center applications. Click to get

[Contact Us](#)



### SFP Optical Module 1.25G Single Optical Fiber 20km

This is a standard SFP optical module. It uses a single mode optical fiber and the speed rate can up to 1.25Gbps, transmission distance up to 20 km.

[Contact Us](#)



### Top SFP Module Suppliers in Singapore: Local vs. Factory Direct (2025)

Buying SFP modules in Singapore? We compare local distributors (RS, FiberTek) vs factory-direct sourcing. Learn how to cut costs by 40% with RCEP & air freight.

[Contact Us](#)

### Optical Module Package Market 2025

South America In South America, the Optical Module Package market is in a nascent growth phase, with Brazil leading in telecommunication infrastructure upgrades. Demand is concentrated in urban

[Contact Us](#)

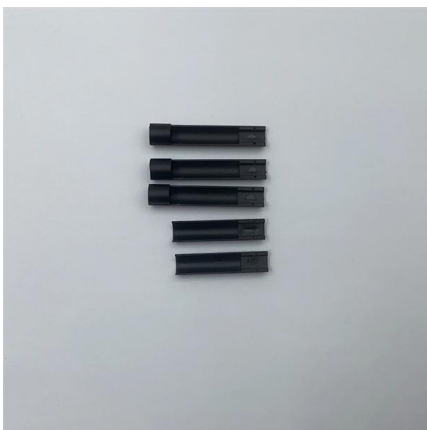

### Small-Form Factor Pluggable (SFP) and Stacking Accessories

Meraki's hardware warranty and return policy and Meraki EOL policy does not apply to Cisco Optics, Cables and accessories in any shape or form. C8455-G2-MX: The compatible SFP modules on the

[Contact Us](#)



## 40G QSFP+ Optical Transceiver Modules , Solid Optics

40G QSFP+ optical transceivers available in multimode (100m & 300m) and single mode options (2km, 10km, 40km) and DAC cables, with a Lifetime Warranty.

[Contact Us](#)



## Single Mode Optical Modules Market 2026

Telecommunication operators are extensively deploying Single Mode Optical Modules in fronthaul and backhaul applications to support 5G network rollouts. The modules enable high-speed, low-latency

[Contact Us](#)

## 10G SFP+ Optical Transceivers , Transceiver Module

FS 10GbE SFP+ module solutions provide a wide variety of 10 Gigabit Ethernet connectivity options for data centers, enterprise wiring closets, Internet Service

[Contact Us](#)



## 40G QSFP+ Transceiver Modules , Optical Transceivers

FS 40G QSFP+ optical transceiver module solutions offer a full range of QSFP+ modules from 150m to 80km reach, and used for high-density switching, routing and data center applications.

[Contact Us](#)



## Optical Transceivers / SFP Modules - High-Performance Compatible

Our SFP+ module and QSFP+ transceiver support 10G, 25G, 40G, and 100G Ethernet, while QSFP-DD and OSFP module are optimized for 200G, 400G and 800G high-performance applications.

[Contact Us](#)



## 40G QSFP+ Transceiver Modules , Optical Transceivers

FS 40G QSFP+ optical transceiver module solutions offer a full range of QSFP+ modules from 150m to 80km reach, and used for high-density switching, routing

[Contact Us](#)



## Optical Transceiver vs. Fiber Optic Module: What's the Difference

IntroductionEngineers, purchasing managers and installers often see the terms transceiver, optical module and fiber optic module used interchangeably -- and that causes confusion. This article

[Contact Us](#)

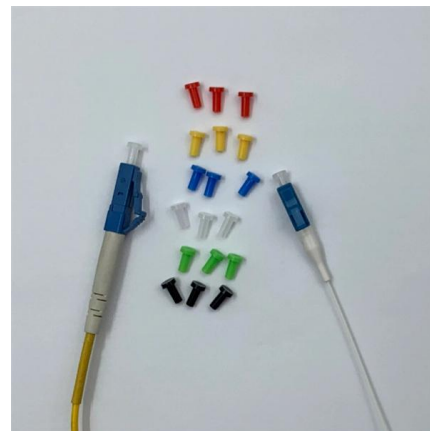

## Optical Transceiver vs. Fiber Optic Module: What's the Difference

IntroductionEngineers, purchasing managers and installers often see the terms Siustuvas imtuvas, optical module and fiber optic module used interchangeably -- and that causes confusion. This

[Contact Us](#)



## Cisco QSFPTEK 40G QSFP+ Module SFP Optical MTP/MPO Multi

Cisco QSFPTEK 40G QSFP+ Module, perfect for high-speed data transfer with MTP/MPO Multi-Mode 40GBASE-SR4 compatibility. Shop now to enhance your network performance in Singapore!

[Contact Us](#)



## Optical Transceiver Speeds Guide: 1G, 10G, 25G, 40G,

WOLON ships a full suite of factory-tested transceivers and cabling to match these needs: SFP/SFP+ for 1G/10G, SFP28 for 25G, QSFP+ and QSFP28 for

[Contact Us](#)

## Contact Us

---

For datasheets, pricing, or custom fiber access solutions, please visit:  
<https://www.frindel.es>