

Optical Splitter ODN Equipment

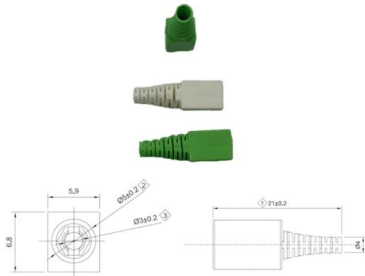



Optical Splitter ODN Equipment



ODN: Optical Distribution Network

ODN usually consists of fiber optic cables, optical connectors, optical splitters, and supporting equipment for installing and connecting these devices.

[Contact Us](#)

PON Network Structure: Understanding ODN,OLT,

What is a PON Network? A passive optical network (PON) is a cabling system that uses optical fibers and optical splitters to deliver services to multiple

[Contact Us](#)



Optical Distribution Network (ODN)

Optical Distribution Network (ODN) Optical distribution network (ODN) is an FTTH optical cable network based on PON devices. Its role is to provide an optical

[Contact Us](#)



Understanding OLT, ONU, ONT and ODN: Building

The Optical Distribution Network (ODN) is the physical infrastructure that interconnects the various components of a PON system. It includes the fiber



FTTH Products , OLT, ONU, Optical Splitters, Fiber

Discover essential FTTH products like OLT, ONU, optical splitters, and fiber distribution boxes. Learn how to design and deploy an efficient FTTH network for

[Contact Us](#)

ODN Optical Distribution Network , What Is It? How It Works?

What is ODN? ODN is an optical distribution network. It is an optical transmission physical channel between OLT and ONU. The main function is to complete the two-way transmission



[Contact Us](#)



What Is an Optical Distribution Network (ODN)? - The Ultimate Guide

An Optical Distribution Network is a passive optical transmission system composed of optical fibers, splitters, distribution frames, and connectors. Its role is to transmit optical signals

[Contact Us](#)



Ubiquitous Fiber Networks with Huawei ODN 3.0

This has resulted in a comprehensive solution that implements full pre-connection, cascading, and uneven optical splitting technologies, culminating in the ODN 3.0

[Contact Us](#)

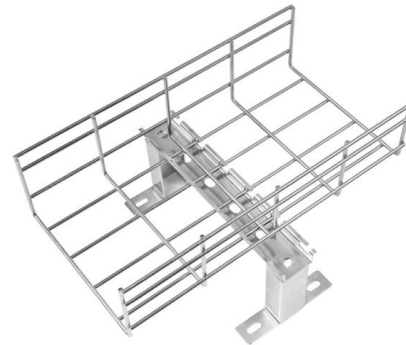

ODN

Optical distribution frame provides functions such as integrated fiber splicing and termination, fiber storage and management, etc. Meanwhile, it could be equipped with ODU and splitter sub-racks.

[Contact Us](#)



PON Network Components Overview: OLT, ONU, ONT,

In ODN, fiber optic cables, connectors, passive optical splitters, and auxiliary components work together. ODN is mainly divided into five parts (in bold)

[Contact Us](#)

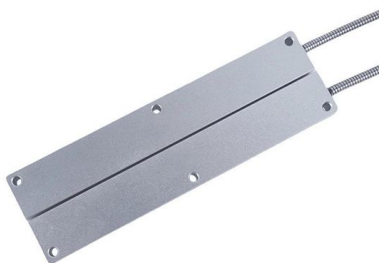
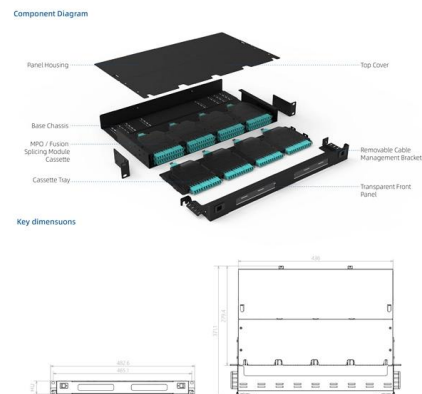

Optical Distribution Network | Bland Technologies

ODN products are initial designed for PON network, and with the development of all-optical network technology, ODN products are widely used. Bland Technologies provides full series of ODN products

[Contact Us](#)



Problems Optical Measurement Systems Solve in Fiber-to-the-Home

The result: fiber optic test equipment that delivers repeatable measurements day after day without manual recalibration. Solving FTTH Testing Challenges Optical measurement systems address the

[Contact Us](#)



ODN Network & Quick ODN , Pre-Terminated Fiber,

Learn how Quick ODN and pre-terminated fiber cables enhance ODN network performance. Discover key FTTH components like PLC splitters, fiber optic

[Contact Us](#)

ODN: A Key Component of Optical Fiber Networks

Introduction The Optical Distribution Network (ODN) is an essential part of modern telecommunications infrastructure. As a core component of Fiber to the Home (FTTH) solutions, ODN is responsible for

[Contact Us](#)



1x2 Digital Optical Audio Splitter for Multi Device Audio Routing

Free delivery and returns on eligible orders. Buy 1x2 Digital Optical Audio Splitter for Multi Device Audio Routing Between Gaming Consoles and For Home Entertainment Equipment (3

[Contact Us](#)

PLC Fiber Splitter: Applications in Optical



Communication

PLC fiber splitter is also widely used in data centers and network equipment, such as PON, FTTH, FTTX, GOPN networks, etc. It provides the necessary optical power

[Contact Us](#)



ODN: Optical Distribution Network Explained

Introduction An Optical Distribution Network (ODN) is the passive fiber infrastructure connecting Internet Service Providers (ISPs) to end-users in Fiber

[Contact Us](#)

ODN Optical Distribution Network In Network And

Looking for reliable ODN solutions? OTRANS provides one-stop FTTH ODN devices, including splitters, distribution boxes, and ODFs. Our optical distribution network

[Contact Us](#)

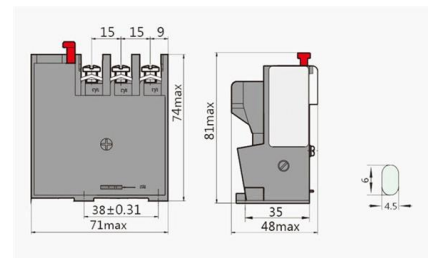

FTTX PON Optical Device Solution - CablesTEC

CablesTEC 's ODN products include optical fiber cables, optical connectors, optical splitters and supporting equipment for installing and connecting these devices.

[Contact Us](#)



Global Fused Biconic Taper Optical Splitter Market Innovation Trends

The Fused Biconic Taper Optical Splitter market has emerged as a critical component in the telecommunications and data transmission sectors, serving to divide optical signals into multiple

[Contact Us](#)



Optical Splitters_Optical Fiber Connectors_ODN Products_Optical

Haian Guangyi Communication Technology Co., Ltd. specializes in manufacturing a full range of passive optical components, including optical splitters, optical fiber connectors, ODN products, and optical

[Contact Us](#)



What Is Optical Distribution Network (ODN)? 2026 FTTH Guide

Spring Optical provides telecom-grade ODN solutions, including high-precision PLC splitters, IP-rated FDBs, and plug-and-play pre-connectorized systems for global operators and ISPs.

[Contact Us](#)



ODN Optical Distribution Network, ODN FTTH-Grandway

It is usually composed of ODF rack, optical fiber cable, optical joint closure (FOC), optical distribution cabinet (ODC, FDH), optical connector, optical splitter, fiber

[Contact Us](#)

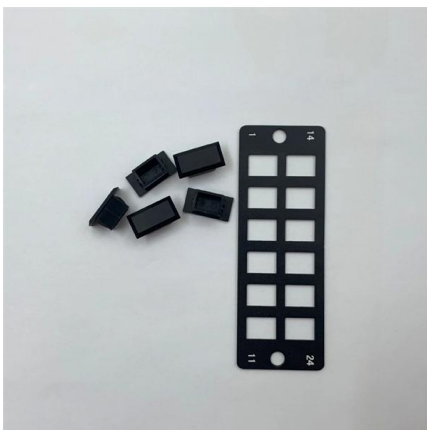



What is optical splitter and its important technical indicators?

An optical splitter is used in ODN to realize that multiple end users share a PON interface. In the PON network, when buildings are scattered and irregular, such as villas, with long

[Contact Us](#)



Decoding OLT, ONU, ONT, and ODN in PON Network

Embarking on an exploration of the fascinating world of Passive Optical Networks (PON), we unravel the roles of OLT, ONT, ONU, and ODN in

[Contact Us](#)

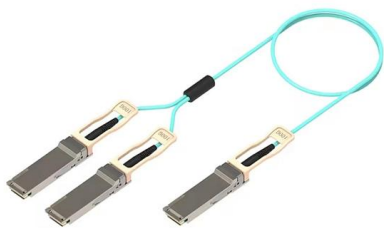

Link Loss Budget Calculator , Fiber Optic Link Loss Budget

Corning's link loss budget calculator will calculate your total link loss and tell you if your system falls within Corning's recommended guidelines.

[Contact Us](#)



The Optical Distribution Network (ODN): The Unsung

Optical Distribution Network ensures fast, reliable FTTH by linking providers to homes with scalable, passive fiber, supporting high-speed

[Contact Us](#)



Contact Us

For datasheets, pricing, or custom fiber access solutions, please visit:
<https://www.frindel.es>