

North Macedonia Imported Mini PLC Splitter





North Macedonia Imported Mini PLC Splitter

yingdapc

Hier sollte eine Beschreibung angezeigt werden, diese Seite lässt dies jedoch nicht zu.

[Contact Us](#)



1x9 Mini PLC Splitter SC APC

We're one of leading 1x9 mini plc splitter sc apc manufacturers and suppliers in China. Source here the best customized 1x9 mini plc splitter sc apc wholesale

[Contact Us](#)

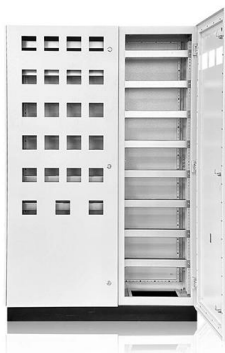

Blockless Mini PLC Splitters With Connectors Types Prices & Spec

What is Blockless Mini PLC Splitters With Connectors? Blockless Mini PLC Splitters With Connectors SC LC FC .. model is used for places that have little space such as FTTH boxes or patch panel and

[Contact Us](#)

SC UPC Mini Type PLC Passive Optical Splitter 1x2 1x4 1x8 1x16

Key attributes Type mini PLC Splitter Model Number PLC Place of Origin Zhejiang, China Brand Name Hongsheng Use FTTH FTTB FTTX Warranty Time one year Network Wireless Lan Working



Splitter SM PLC1x8-1.5m-SC/APC,G657A

Home Fiber Optic Passives Couplers Splitter SM PLC1x8-1.5m-SC/APC,G657A Couplers, Fiber Optic Passives Splitter SM PLC1x8-1.5m-SC/APC,G657A SKU: 607306 Availability: In stock 0,00 den

[Contact Us](#)

1x8 SingleMode Mini Module Blockless PLC Splitter

This splitter utilizes Planar Lightwave Circuit (PLC) technology without the need for traditional block optical elements, making it more reliable, with lower insertion loss and a smaller form factor.

[Contact Us](#)

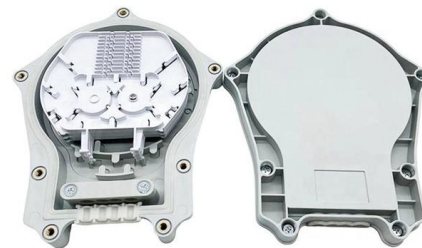

Mini PLC Splitter

The mini PLC splitter is compactly packaged using a steel pipe and features a 0.9mm loose tube for fiber outlet. It is equipped with a connector plug and is

[Contact Us](#)





North Macedonia (MKD) Exports, Imports, and Trade

The following section uses the most recent trade data from partners of North Macedonia, displaying Trade Value, which represents the total monetary value of

[Contact Us](#)

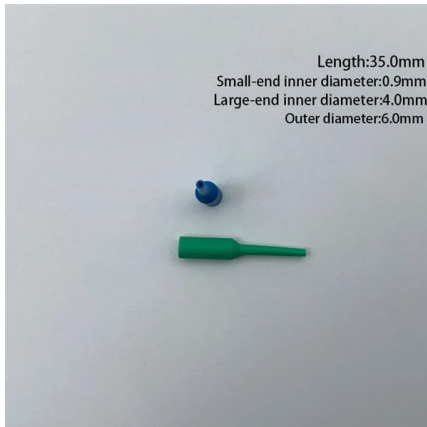

Find Buyers, Importers, Distributors in Macedonia

Get qualified B2B leads and connect directly with importers and distributors in Macedonia. Start selling to verified Macedonia buyers today!

[Contact Us](#)

1X8 PLC Splitter, SC/PC 0.9mm Mini Blockless Fiber

1×8 PLC Splitter, Mini Blockless Type, Singlemode, SC/UPC PLC S plitter also referred to as optical splitter, or Fiber splitter, is an even split ratio from one input

[Contact Us](#)

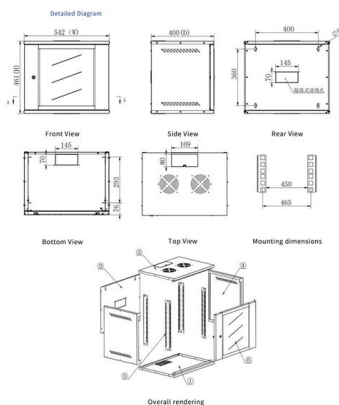

Hot Selling 1:8 Mini Optical Fiber PLC Splitter 1m 0.9mm Mini Steel

We mainly manufacture fiber distribution box, plc splitter, fiber Patch cord, fast assembly connector, fiber adapter, fiber joint closure box, fiber terminal box, optical distribution frame and optical cross cabinet.

[Contact Us](#)



Wholesale Plc Splitters from Manufacturers, Plc Splitters Products at

Source over 252 plc splitters for sale from manufacturers with factory direct prices, high quality & fast shipping.

[Contact Us](#)



North Macedonia

However, North Macedonia still needs to further implement a national system for estimating greenhouse gas emissions. This entails collecting greenhouse gas emissions data for all IPCC categories,

[Contact Us](#)

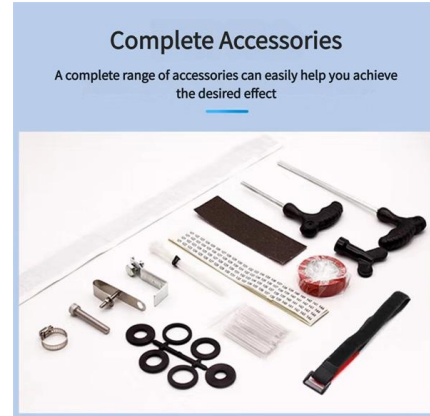

2x4 Blockless Mini 0.9mm PLC Fiber Splitter FC LC

Welcome to buy our high quality products or wholesale our customized 2x4 blockless mini 0.9mm plc fiber splitter in stock with our factory. Also, free sample is also available if necessary.

[Contact Us](#)



1x17 Mini Type Fiber PLC Splitter

We're one of leading 1x17 mini type fiber plc splitter manufacturers and suppliers in China. Source here the best customized 1x17 mini type fiber plc splitter wholesale

[Contact Us](#)

PLC Splitter, Fiber Splitters, Always Ready



FS PLC Fiber Optic Splitters,
Bare/Blockless/ABS/LGX Splitter/Rack Mount
Types, support 1xN light distribution, with low IL
and PDL for high-reliability transmission.

[Contact Us](#)



1X8 PLC Splitter, Mini Module, SC/APC

Buy the high quality and highly efficient 1x8 plc splitter, mini module, sc/apc with our factory. We are one of the leading manufacturers and suppliers in China,

[Contact Us](#)



1x4 Blockless PLC Splitter SC APC Mini Module For FTTH Fiber Optic

fiber optic splitter is a device to split optical signal into several beams, We supply 1x2, 1x4, 1x8, 1x16, 1x32 min blockless plc splitter.

[Contact Us](#)

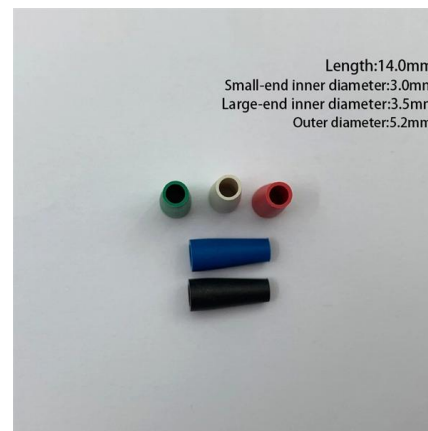

1x8 Mini Type SCUPC Fiber PLC Splitter

High quality 1x8 Mini Type SCUPC Fiber PLC Splitter from China, China's leading product market Fiber Optic Passive Components product market, With strict

[Contact Us](#)



FTTH 1*8 plc splitter fiber optic plc splitters with sc apc

Product Description Planar lightwave circuit (PLC) Splitters is a type of optical power management device that is fabricated using silica optical waveguide

[Contact Us](#)



1*8 0.9mm Mini Steel PLC Fiber Optic Splitter 1 8 Passive PLC Splitter

Hot Tags: 1 by 8 mini metal plc splitter, China, manufacturers, suppliers, factory, wholesale, customized, DWDM Demux Simplex 16 channels Pigtailed ABS Module, hpe bladesystem c class 40g qsfp to

[Contact Us](#)

PLC Splitter

This 1x8 Fiber PLC Splitter with 1 input and 8 output fibers with an even split ratio across all fibers regardless of input wavelength. PLC Splitters are available with 900µm loose tube singlemode fiber

[Contact Us](#)

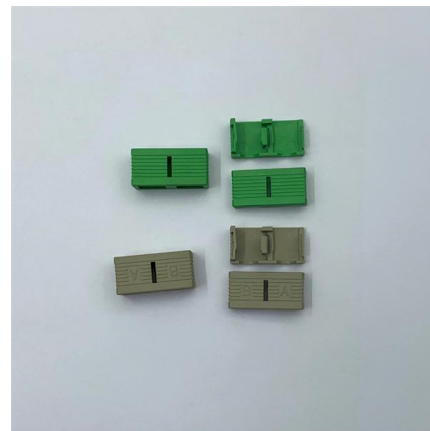

Fiber PLC Splitter, Mini Module, 900um, SC/APC, Singlemode

Buy Fiber PLC Splitter, Mini Module, 900um, SC/APC, Singlemode from Honalink. High-quality fiber optic networking products designed for reliable performance,

[Contact Us](#)



PLC Control Panel In North Macedonia

PLC Control Panel Manufacturers In North Macedonia Being one of the best PLC Control Panel Manufacturers in North Macedonia, we have used superior quality raw materials while manufacturing

[Contact Us](#)



Mini Module PLC Fiber Splitter -JPT Laser

Supports an operating wavelength range of 1260-1650 nm, meeting the needs of various optical splitting applications. Features low insertion loss with dependable optical performance, enhancing link quality

[Contact Us](#)

1:8 1:4 Mini PLC Splitter Splice Box 24 Core Optical Fiber Fusion Box

Product name Fiber access terminal box Color Customized Product Model FDB-8E+1ZB Packing Size 260*200*60 mm Ports 3 inlet port 12.5 mm / 8 out port 9.5 mm Application cassette splitter or mini

[Contact Us](#)



PLC Splitter Bulk Supplier , Baymro B2B Solutions

Power your fiber networks with high-performance PLC splitters. Global B2B manufacturer offering bulk optical splitting solutions with precise insertion loss

[Contact Us](#)



1×8 Mini PLC Splitter With SC Connector

We're one of leading 1×8 Mini PLC Splitter With SC Connector manufacturers and suppliers in China. Source here the best customized 1×8 Mini PLC Splitter With

[Contact Us](#)



Hot Selling PLC Splitter: Top Picks for 2025

Discover the top hot selling PLC splitters driving demand in 2025. Learn why 1x4, 1x8, and 1x16 configurations lead the market. Click to explore high-performance, cost-efficient solutions for B2B

[Contact Us](#)

Contact Us

For datasheets, pricing, or custom fiber access solutions, please visit:
<https://www.frindel.es>