

How to use the Xiaomi transceiver terminal box





How to use the Xiaomi transceiver terminal box



Xiaomi TV Box: How to Use a USB Drive

Once formatted, I'll demonstrate how to properly connect the USB drive to your Xiaomi TV Box and access its contents effortlessly.

[Contact Us](#)

How to: Initial Setup & Configuration of the the Xiaomi Mi Box Android

Initial setup is simple and straight forward thanks to the Mi Box's use of Android TV software. Once you have the HDMI cable and power cord plugged in you'll begin the software setup and

[Contact Us](#)



Xiaomi TV Box S (2nd Gen) user manual_en

Xiaomi TV BOX S (2nd Gen) Important Product Information MODEL: MDZ-28-AA Beijing Xiaomi Electronics Co.,Ltd Simplified EU Declaration of Conformity Hereby, Beijing Xiaomi Electronics

[Contact Us](#)

How to Use a USB Drive on Xiaomi TV Box (Full Guide)

Welcome, today I will show you How to Use a USB Drive on Xiaomi TV Box. Make sure to subscribe for more solutions. Thank you for watching!



XIAOMI MI BOX MANUAL Pdf Download , ManualsLib

View and Download Xiaomi Mi Box manual online. Mi Box media player pdf manual download. Also for: Mdz-16-ab.

[Contact Us](#)

XIAOMI MI TV BOX S QUICK START MANUAL Pdf

View and Download Xiaomi Mi TV Box S quick start manual online. Mi TV Box S set-top boxes pdf manual download. Also for: Mdz-32-aa.



[Contact Us](#)

50km/spool



User manual Xiaomi Mi Box 3 (English)

View the manual for the Xiaomi Mi Box 3 here, completely for free. This manual belongs to the media players category and has been rated by 8 users with an

[Contact Us](#)



Xiaomi Mi TV Box: How To Expand Storage! [Setup External

Looking for a way to set up external storage on Xiaomi MI TV Box S 2nd Gen 4K by using a USB Flash Drive/Pen Drive/ SSD/HDD/Thumb Drive or any other external drive? Want to know how to expand

[Contact Us](#)



Mi Box User Guide

Leave the last trouble with the remote control, you can now remotely controls Mi Box via a mobile app! Open the Mi Store, locate and install on your mobile phone «Remote Control» application.

[Contact Us](#)

Xiaomi Mi Box 3 Manual , ManualsLib

Xiaomi Mi Box 3 User Manual View and Read online. Est. reading time 2 minutes. Mi Box 3 Amplifier manuals and instructions online. Download Xiaomi Mi Box 3 PDF

[Contact Us](#)

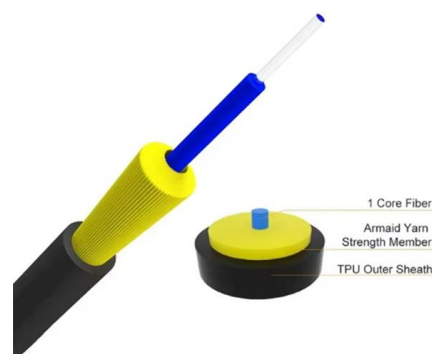

How Does Xiaomi TV Box Work in South Africa?

In this video, we explain how the Xiaomi TV Box works in South Africa. This smart streaming device connects to a TV via HDMI, turning it into an Android-powered entertainment hub.

[Contact Us](#)



Xiaomi TV Box: How to Connect to WiFi

In this video, I showed you how to connect your WiFi to your Xiaomi TV Box so you can access the internet and stream content without issues. Whether you're using the Xiaomi TV Box with Android TV

[Contact Us](#)

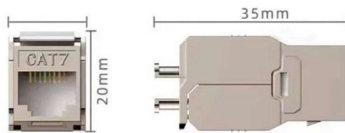

How to Set Up and Use Android TV Box (Mi Box)

The Mi Box, developed by Xiaomi, is one such device that provides powerful performance, great software support, and an intuitive user interface. This article will guide you

[Contact Us](#)

Xiaomi 4K Ultra HD TV Box S 2nd Gen User Guide

Xiaomi TV Box S (2nd Gen) also offers Google-2 Chromecast built-in technology that lets you Stream favorite entertainment and apps from your phone, tablet or laptop right to your TV or speakers.

[Contact Us](#)

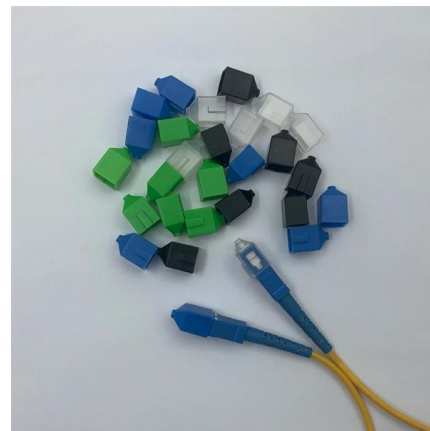

Xiaomi TV Box User Manuals PDF , Manualsnet

Each product comes with comprehensive Xiaomi user manuals, ensuring easy setup and optimal use. For troubleshooting and enhanced functionality, refer to the detailed Xiaomi TV Box instructions.

[Contact Us](#)



How to Set Up and Use Android TV Box (Mi Box)

Just got the Android TV Mi Box and wondering how to set up Android TV box on your old TV? Here is how to set up and use Android TV Mi box.

[Contact Us](#)

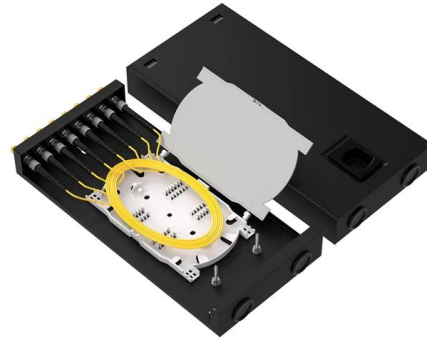

Instructions of Mi Box S

Easy management of applications and games: Use mobile phone to install management applications and games for TV, easy and convenient. Mobile phones are remote controls: Free from the shackles

[Contact Us](#)

Xiaomi TV Box S (2nd Gen) Setup

Xiaomi TV Box (2nd Gen) with Mi TV Box (1st Gen) After powering on this device, connect it to one of your TV's HDMI ports. Now depending on your

[Contact Us](#)

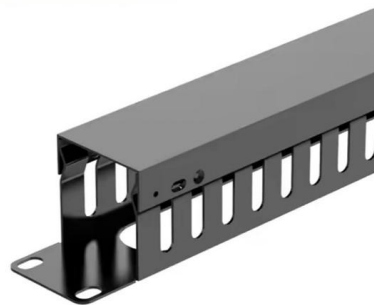

XIAOMI MI BOX SETUP MANUAL Pdf Download

View and Download Xiaomi Mi Box setup manual online. Gibson Connect TV. Mi Box set-top boxes pdf manual download.

[Contact Us](#)

Mi Box Basic Knowledge FAQ



25.Q:Matters needing attention when using the remote control APP and xiaomi box's own remote control. A:Xiaomi box is equipped with a remote control and uses infrared transmission, so the

[Contact Us](#)



Mi Box Basic Knowledge FAQ

A:The Mi box can be used on TV with HDMI input or AV composite input is recommended that you use Mi box on a TV with HDMI, which can fully guarantee the viewing effect.

[Contact Us](#)



Instructions of Mi Box S

After the connection is completed, turn on the TV, power amplifier and Mi box, and enjoy the audio-visual experience brought by Mi box! Use method of remote control Power: short press on/off, long

[Contact Us](#)



How to set up my Xiaomi TV box

To set up your Xiaomi TV Box, First, you'll need to connect it to your TV and Wi-Fi network. Once connected, you can download any apps you want through the Xiaomi app store.

[Contact Us](#)





Xiaomi TV Box: How to Connect & Setup (Full Guide)

Welcome, today I will show you How to Connect & Setup Xiaomi TV Box. Make sure to subscribe for more solutions. Thank you for watching!

[Contact Us](#)

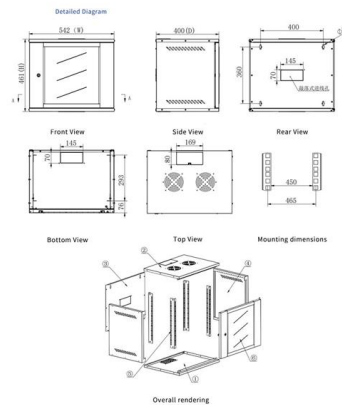

Xiaomi TV Box: How to Connect Bluetooth Speaker

Whether you're using a Xiaomi TV Box with Android TV or the Xiaomi TV Box S 2nd Gen with Google TV, this step-by-step guide will help you pair your Bluetooth speaker quickly.

[Contact Us](#)

How to Connect Bluetooth Devices to Xiaomi Mi TV Box! [Speaker

Don't know how to pair and use Bluetooth Headphones, Speakers, etc. with Xiaomi MI Box S Google TV? Searching for an easy way to connect Wireless devices to Xiaomi TV Box via Bluetooth? Fret not

[Contact Us](#)

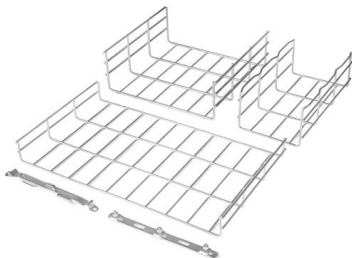

How to Set Up and Use the Mi Box 4K

What is the Mi Box 4K? The Mi Box 4K is a streaming device developed by Xiaomi that allows you to watch content on your TV using internet connectivity. It supports resolutions up to 4K

[Contact Us](#)



Contact Us

For datasheets, pricing, or custom fiber access solutions, please visit:
<https://www.frindel.es>