

Handheld Spectrometer for Heavy Metal Testing

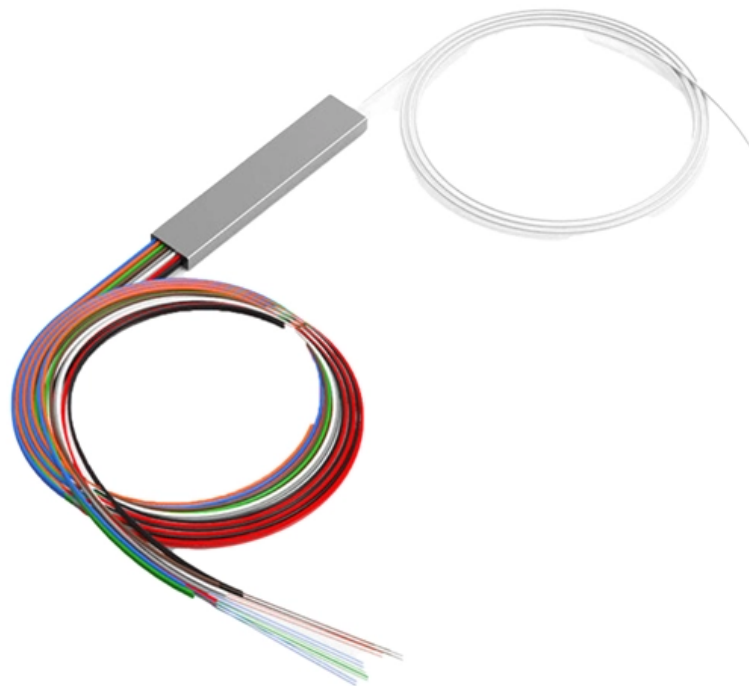

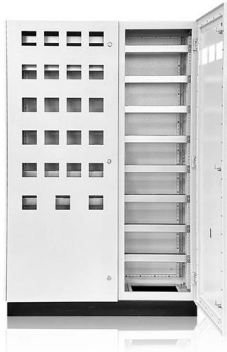

Handheld Spectrometer for Heavy Metal Testing



Ultra-portable, smartphone-based spectrometer for heavy metal

Developed handheld spectrometer along with commercially imported chemical kits provides an innovative chemo-electronic system to measure heavy metal contamination presence in water

[Contact Us](#)

Handheld XRF Spectrometers for Elemental Analysis

Bruker's portable XRF solutions offer multi-element analysis with off-the-shelf or customized methods to provide actionable results at any stage of the food

[Contact Us](#)

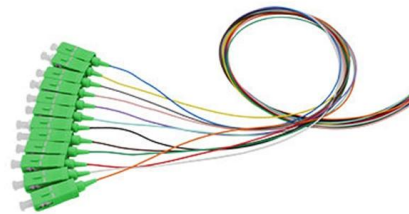

Handheld Analyzer for Soil Heavy Metals

In- field online analysis of various elements during raw material inspection process control and finished product inspection, the identification of metallic materials

[Contact Us](#)

Ultra-portable, smartphone-based spectrometer for heavy metal

Developed handheld IoT-enabled and standalone spectrometer system for offline heavy metal measurement Specifications of used white light-emitting diode as a source



Mobile Metal Analyzer

For onsite metal analysis, SPECTRO offers a complete range of mobile metal analyzer products, from handheld XRF to portable Arc Spark OES spectrometers.

[Contact Us](#)



Handheld Spectrometer: Portable Analysis Tools

Discover the best handheld spectrometers for field analysis. Explore top-rated tools for metal, pharmaceutical, and food safety testing. Click to find reliable suppliers and expert insights.

[Contact Us](#)



S450 Handheld X-ray fluorescence soil heavy metal

S450 Portable soil heavy metal analyzer X fluorescence spectrometer soil heavy metal detection analyzer 1. Application fields and characteristics Excellent

[Contact Us](#)





Portable Metal Analyzer

The SPECTROPORT portable arc spark spectrometer is ideal for many applications in the metal producing, processing, and recycling industries. Find out more.

[Contact Us](#)

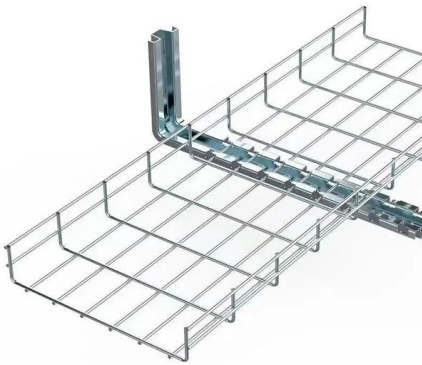

Handheld Spectrometers: Portable Analysis Solutions

Handheld spectrometers are shifting from niche tools to essential assets in quality control, safety, and supply chain management. The surge in demand for non-destructive testing (NDT) solutions has

[Contact Us](#)

Portable XRF Metal Analyzer

This rugged 245x250x90mm portable spectrometer delivers fast, precise

[Contact Us](#)



XRF Metal Analyzer: Quick results , Alloytester

A handheld Bruker metal analyzer is a robust, easy-to-use instrument for metal identification. Our metal analyzer can determine the composition and grades of

[Contact Us](#)



AELAB Portable XRF Spectrometer 5000 - Handheld

Discover the AELAB Portable XRF Spectrometer 5000 - a handheld, high-precision analyzer for alloys and precious metals. Fast results, rugged design, and lab

[Contact Us](#)



SPECTRO xSORT XRF Handheld Analyzer for many

Fast on-site elemental analysis: The SPECTRO xSORT handheld XRF is the ideal analyzer for compliance testing and quick screening of non-metallic samples.

[Contact Us](#)



Ultra-portable, smartphone-based spectrometer for heavy metal

Heavy metals are very toxic and hazardous for human health. Onsite screening of heavy metal contaminated samples along with location-based automation data collection is a tedious job.

[Contact Us](#)



Chinese Top Brand WALTER Metal Gold Tester Spectral Analyzer Handheld

Chinese Top Brand WALTER Metal Gold Tester Spectral Analyzer Handheld Heavy Metal Spectrometer Portable Handheld XRF

[Contact Us](#)





XRF Metal Analyzer

XRF metal testers provide accurate and precise chemical composition of a sample. Handheld spectrometers for metal analysis however can not provide any

[Contact Us](#)

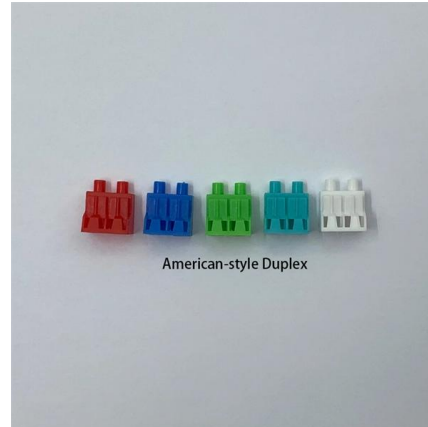

Portable VA Analyzer

Portable voltammetric analyzers for the determination of trace levels of heavy metals in water in the field.

[Contact Us](#)

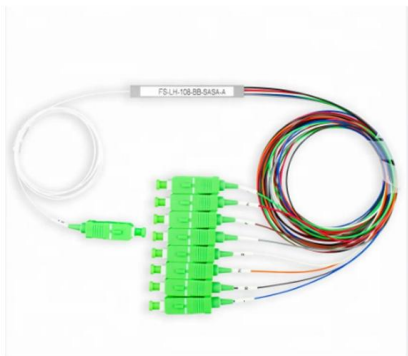

Portable XRF Spectrometer for soil heavy metal

The Portable XRF Spectrometer for soil heavy metal analysis is a compact, handheld tool designed to measure heavy metal levels in soil. Using X-ray fluorescence, it

[Contact Us](#)

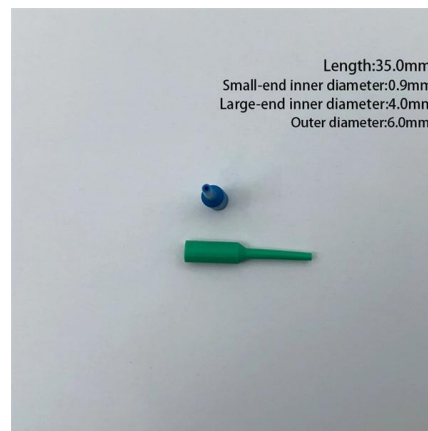

Handheld Analyzer for Soil Heavy Metals

Handheld Analyzer for Soil Heavy Metals For purchase.Small, easy to carry, it supports handheld test It provides rapid and nondestructive detection, delivering

[Contact Us](#)

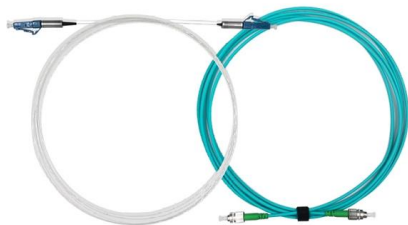



Ultra-portable, smartphone-based spectrometer for heavy metal

This manuscript reports an ultra-portable, rapid, cost-effective, and easy-to-use solution for onsite heavy metal concentration measurement in drinking water samples.

[Contact Us](#)



Portable Spectrometer for Metal Analysis

SISCO portable spectrometer is equipped with a high-definition TFT industrial touch screen, imported high-performance X-ray emitting tube and ultra-high resolution

[Contact Us](#)

portable spectrometer , Belec

Our Belec Compact Port HLC is your reliable partner for mobile metal analysis. With its robust design and state-of-the-art technology, it delivers accurate results,

[Contact Us](#)



Handheld Xrf Metal Analyzer X-ray Fluorescence

Handheld Xrf Metal Analyzer X-ray Fluorescence Spectrometer RoHS Testing Analyzer, Find Details and Price about Mineral Analyzer Mining Analyzer from

[Contact Us](#)



Handheld XRF Basics

An X-ray fluorescence spectrometer (XRF) is an instrument used for elemental analysis of a variety of different materials. Some examples include: metal alloys,

[Contact Us](#)



XRF Spectrometers and Metal Analyzers , Worldoftest

Portable & Benchtop Models Available: Choose from handheld XRF analyzers for on-site testing or benchtop spectrometers for high-throughput lab analysis. User

[Contact Us](#)

Portable Spectrometer for Metal Analysis

The handheld spectrometer mainly uses XRF technology to quickly and accurately analyze the content of multiple elements in the sample within a few seconds to

[Contact Us](#)



8-Port PLC Fiber Splitter Box

12-Port SC Fiber Splitter Box

Size: 235*215*75mm
Material: ABS, IP65,



Heavy Metal Analysis

A lightweight portable heavy metals analysis system, offering accessories and consumables for up to ten possible parameters in a single waterproof hard-shell

[Contact Us](#)



Portable XRF Analyzer for Accurate Metal Analysis

SuperbMelt portable gold testing machine ensures quick, non-destructive metal analysis. Get reliable results on-the-go with our XRF analyzer portable.

[Contact Us](#)



56 ELEMENT HANDHELD XRF ANALYZER -

No need for sample preparation, directly measures and analyses the surface of goods, its handheld benefit helps the instrument achieve a quick measurement

[Contact Us](#)

Contact Us

For datasheets, pricing, or custom fiber access solutions, please visit:
<https://www.frindel.es>