

Government and Enterprise Intelligent Distribution Box Renovation Project





Government and Enterprise Intelligent Distribution Box Renovation



Research on intelligent distribution network automation design

Finally, take a specific urban distribution network project as an example and its revamping scheme is introduced. The intelligent distribution network automation design scheme

[Contact Us](#)

Power Distribution Cabinet Development: Revolutionizing Electrical

Power Distribution Cabinets, often referred to as electrical enclosures or distribution boards, serve as an integral component in electrical systems, facilitating the efficient and secure distribution of power

[Contact Us](#)

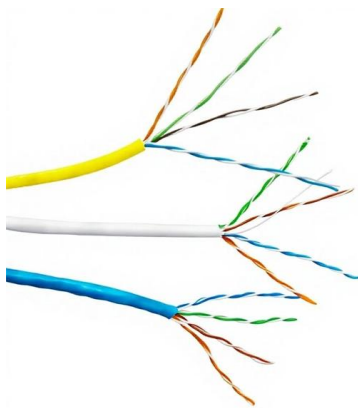

Design of Intelligent Distribution Control System Based on BP Neural

Intelligent power distribution system is based on the needs of users and in accordance with the standard specifications of the power distribution system under the premise of secondary development of a set

[Contact Us](#)

Intelligent final distribution scheme

In 2018, the plant undertook a significant upgrade to its electrical distribution system to enhance its production capabilities and ensure a stable power supply. The project involved the installation of



Construction of IoT management system for intelligent monitoring of

The results are applied in the construction of Zhejiang intelligent distribution room, providing important guidance for the standardized construction of intelligent distribution room in China.

[Contact Us](#)

Case Study-How to Customize a Distribution Box for

Customizing a distribution box is crucial for meeting project specifications, improving safety and functionality, and protecting against

[Contact Us](#)

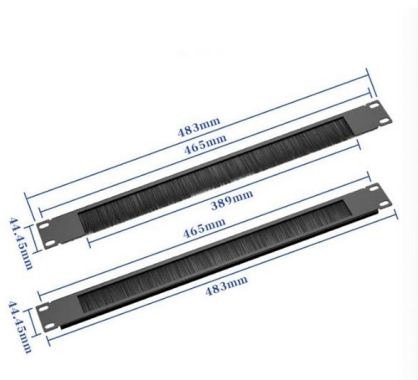

Impact of digital government construction on the intelligent

In the digital age, driving the intelligent transformation of enterprises is a crucial research topic. This study examines the impact of digital government development on enterprise

[Contact Us](#)

Intelligent Remote Distribution Box Monitoring Solution



Remote distribution box monitoring By leveraging the intelligent remote monitoring function, you can collect the electric meter readings and implement networked

[Contact Us](#)



Electrical Distribution Boxes for Power Distribution

Electrical distribution boxes for modular power distribution and installation. Flexible distribution solutions for industrial and building electrical infrastructure.

[Contact Us](#)

Electrical Distribution Modernization and Upgrade Solutions

Modernization solutions for optimizing existing switchgear and electrical distribution equipment to make it more reliable, safer, and in service longer.

[Contact Us](#)

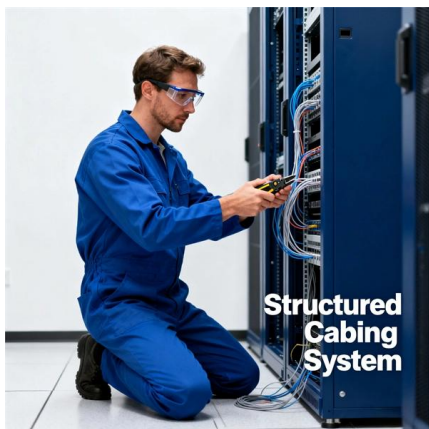

A New Generation of Intelligent IoT Technology in Power Distribution

Based on the comprehensive analysis of the application requirements of the intelligent power distribution system and basis of the key technology research, the research prospects for the

[Contact Us](#)

Intelligent Distribution , Solutions , ABB



Digital technologies such as Cloud Computing, Big Data, Internet of Things (IoT), Artificial Intelligence (AI) and Industry 4.0 are phenomenon which are changing

[Contact Us](#)



Intelligent Distribution Box

Through its wide-voltage and wide-temperature design, high level of integration, intelligent diagnostic capabilities, and flexible configuration, it provides vehicles with an efficient, reliable, and easy-to

[Contact Us](#)

Intelligent distribution for Data Centers

In this session, we will examine ABB intelligent distribution architectures dedicated to electrical distribution systems in Data Centers. ABB

[Contact Us](#)



A Design Method of Intelligent Power Distribution Room

Abstract The power distribution system is becoming intelligent supported by using the ubiquitous Internet of Things and a power distribution room. As the terminal of the power grid, the power distribution

[Contact Us](#)

Intelligent Power Distribution Box Solution



Intelligent power distribution box is composed of traditional leakage protector, air switch, AC contactor and KC868-H8. Compared with the traditional power

[Contact Us](#)

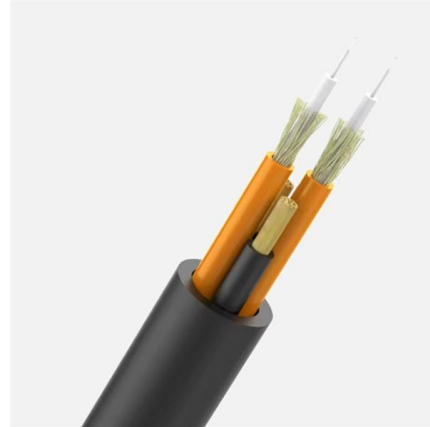

Distribution Network Digital Transformation and Resiliency Project

The project will assist Uzbekistan in upgrading 26 critical distribution substations, digitalizing the network operations, and building on sector reform to strengthen the operations of the Joint Stock Company

[Contact Us](#)

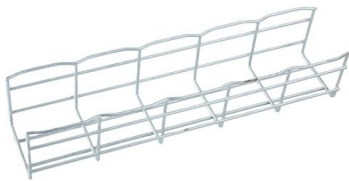

Research on the Driving Mechanism of Intelligent Renovation

These include "government-enterprise collaboration" and "industry chain collaboration" along with "strengthening the foundation" and "enhancing capabilities." The aim is to promote successful

[Contact Us](#)



WO2024255014A1

The present invention provides an intelligent distribution box and a signal transmission method.

[Contact Us](#)





Impact of digital government construction on the intelligent

Abstract In the digital age, driving the intelligent transformation of enterprises is a crucial research topic. This study examines the impact of digital government development on enterprise

[Contact Us](#)

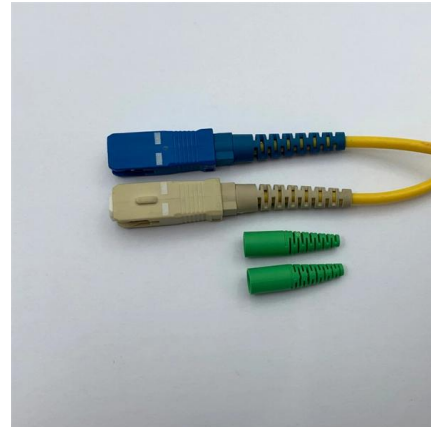

Intelligent distribution box solution: Providing safe and efficient

By optimizing circuit design and integrating energy-saving components, our products can reduce power loss by 15% to 20%, helping customers achieve their carbon neutrality goals.

[Contact Us](#)



India: West Bengal Electricity Distribution Grid Modernization Project

The project objective is to improve the operational efficiency and reliability of electricity supply in selected areas of West Bengal.

[Contact Us](#)



CIREN 2025 , Huawei Releases New IDS Features to

During the event, Huawei announced new features for the IDS and showcased its latest achievements in the global digital distribution field, with the aim of digitally enabling future distribution networks.

[Contact Us](#)





Pathways for the development of future intelligent distribution grids

Acknowledging large differences between European distribution grids, this paper presents pathways for distribution system operators developed within the scope of the UNITED-GRID project,

[Contact Us](#)

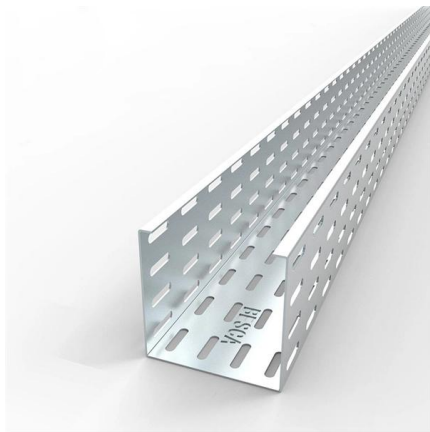

Central Public Works Department (CPWD) Tender

The Central Public Works Department (CPWD), a Central Government Ministry/Department, invites open percentage bids for the "Renovation of E-block 3rd floor including

[Contact Us](#)

Analysis and Improvement of Intelligent Low-voltage

Download Citation , On Dec 1, 2022, Yipeng Ding and others published Analysis and Improvement of Intelligent Low-voltage Integrated Power Distribution Box in Power Internet of Things , Find, read

[Contact Us](#)



Singapore , Smart City Project with Intelligent Power

For a smart city project in Singapore, we delivered custom intelligent power distribution boxes designed to integrate remote monitoring and alert

[Contact Us](#)



Contact Us

For datasheets, pricing, or custom fiber access solutions, please visit:
<https://www.frindel.es>