



EML Single Fiber Bidirectional Original Authentic Product





EML Single Fiber Bidirectional Original Authentic Product



Ortel: L-EML-Transmitterboard 3644 und 3645

Integrated within the design is Ortel's patented predistortion technology to provide outstanding noise and distortion performance. There is an RF test port on board

[Contact Us](#)

Understanding Different Types of Transmitters in

Explore different types of transmitters in transceivers: EML, VCSEL, DFB, FP, and MZM for optimal optical communication performance.

[Contact Us](#)



Single-fiber Transceiver & Dual-fiber Transceiver

Single-fiber optical modules use only one optical fiber for bidirectional transmission, which has space advantages. The dual-fiber optical module uses two optical

Lightwavestore > 15xxnm C-band SMF EML >

Product name: LIM100. Product code: A11-0016-401. With EA modulator. Average modulated output > 1dBm. 7-pin butterfly 9.2mm package / no locker. 1.5m SM

[Contact Us](#)



TL-SM321B-2 , 1000Base-BX WDM Bi-Directional SFP

What This Product Does TP-LINK’s TL-SM321B-2 and TL-SM321A-2 is designed to work in a pair to create an on-site gigabit fiber communication up to 2km (2,000

[Contact Us](#)

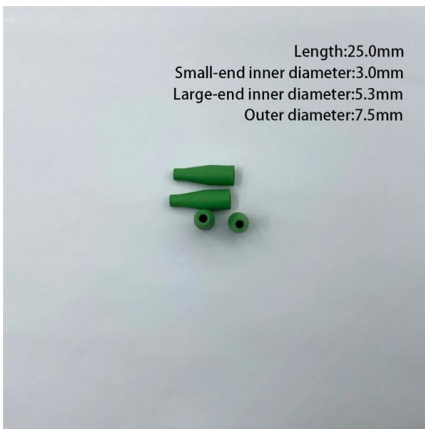

FiberMall Launches 100G QSFP28 ZR4 BIDI , FiberMall

FiberMall's 100G QSFP28 BIDI (20km/40km/80km) series optical module products The 100G QSFP28 ZR4 BIDI product for 100G BIDI adopts

[Contact Us](#)

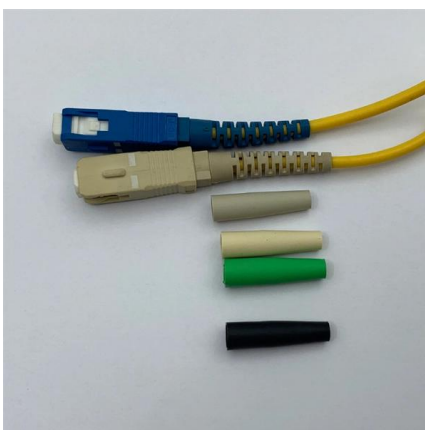

Single Fiber vs Dual Fiber Transceivers Understanding

Single fiber transceivers, like the Bidi Transceiver, use one fiber for bidirectional data, while dual fiber transceivers require two fibers for separate TX

[Contact Us](#)



10G BIDI SFP+ LC Single Fiber Transceiver

The 10G BIDI SFP+ LC Single Fiber Transceiver is designed to

[Contact Us](#)



EMLs

Lumentum manufactures indium phosphide (InP) externally-modulated lasers (EMLs) in our internal wafer foundry. These EMLs consist of a distributed feedback (DFB) diode lasers followed by a

[Contact Us](#)

Electroabsorption-modulated laser as optical transmitter

Section 6 takes the leap towards full-duplex signal transmission, for which a single EML simultaneously serves as transmitter and coherent receiver.

[Contact Us](#)



Electroabsorption modulated laser as optical transmitter and receiver

Section 6 takes the leap towards full-duplex signal transmission, for which a single EML simultaneously serves as transmitter and coherent receiver. Applications such as full-duplex analogue signal

[Contact Us](#)





BiDirectional Single mode fiber SFP

I have been trying to track down a pair of SFP's to run bi-directionally over a single strand of single mode fiber. I found this model MFEBX1 that will TX at 1310nm and RX at 1550nm, but I

[Contact Us](#)

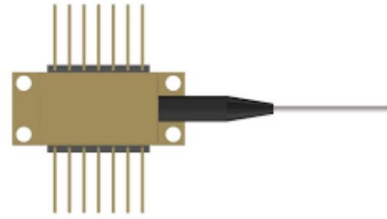

50G SFP56 BiDi EML 10km/30km Single-fiber Bidirectional

The GIGALIGHT 50G SFP56 BiDi single-fiber bidirectional optical transceiver module is used for 5G fronthaul, conforms to 50G Ethernet transmission protocol, and is also compatible with 50G eCPRI

[Contact Us](#)

283VCS/283VCL EML Die for Applications Up to 1.6-Gb/s (200

Broadcom offers a range of single-mode, electro-absorptive modulated (EML) laser diode chip and chip-on-carrier products with 1.3-um CWDM wavelengths, for use in data centers and other applications

[Contact Us](#)

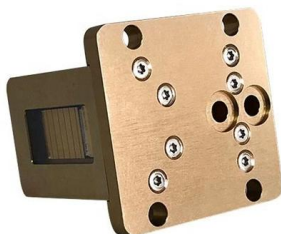
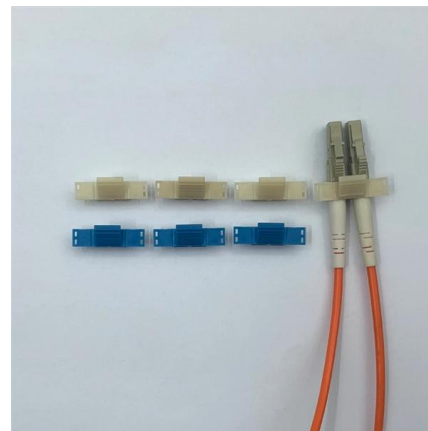

Differences Between Dual Fiber SFP and Simplex SFP

As mentioned above, dual fiber SFP transceiver adopts a duplex interface (now normally LC ports), so two fiber connections are required at least.

[Contact Us](#)



Industrial Fast Ethernet to Single Mode Fiber Optic

The ETH-FIBER-SM-ST or ETH-FIBER-SM-SC is a bi-directional externally powered 10/100 Ethernet to Single Mode Fiber Optic Converter which converts a standard

[Contact Us](#)

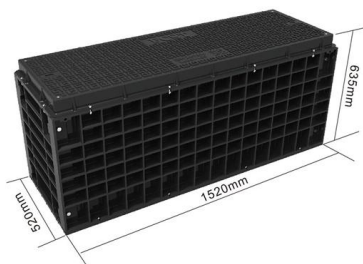
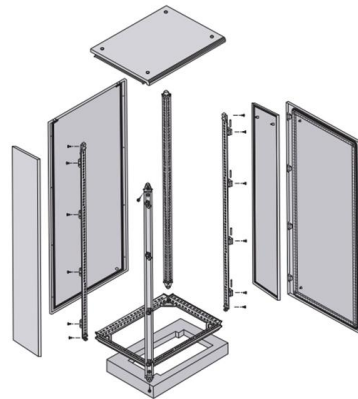

BiDi Optical Modules: Unlocking Single-Fiber

Comprehensive guide on BiDi Optical modules, detailing single-fiber bidirectional connectivity, deployment tips, troubleshooting, and multi-speed

[Contact Us](#)

200 Gb/s / ? Bidirectional Coherent PON Solutions Demonstrated over

Abstract--We demonstrate 200 Gb/s bidirectional coherent PON solutions using a simplified optical network unit (ONU) over 19 km of field-installed fiber. The ONU receiver is

[Contact Us](#)



Bi-Di Communication over a Single Fiber Strand

A Wave Division Multiplexing (WDM) Media Converter, can link Copper to Fiber, convert Single Mode to Multimode, or extend a Multimode network over Single Strand Fiber, also known as Simplex Fiber.

[Contact Us](#)

BiDi Optical Module: Features And



Applications

A BiDi (Bidirectional) optical module adopts WDM (Wavelength Division Multiplexing) bidirectional transmission technology, enabling simultaneous bidirectional transmission within an

[Contact Us](#)



RF Over Fiber Link System 0.1-40 GHz Analog/Digital

This rack-mount RF-over-Fiber (RFOF) system transports analog and digital RF signals with high fidelity over distances up to 500 km and frequencies up to 100

[Contact Us](#)

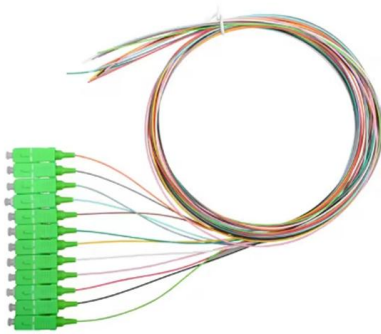

100 Gbps and 200 Gbps EML

> Optoelectronic Devices > InP Optoelectronics
> 100 Gbps and 200 Gbps EML Networking 100 Gbps and 200 Gbps EML Optimal transmitter devices for optical

[Contact Us](#)



Bi-Directional Single Fibre Digital Transceivers

Bi-directional (Bi-Di) transceivers allow a physical capacity doubling of existing installed legacy single mode fibre links. Using special Bi-directional Optical Sub

[Contact Us](#)





FiberEdge Single Channel 56GBd PAM4 Linear EML Driver Die

The FiberEdge GN1862 is a high-performance, single-channel, differential input and single-ended output linear EML driver for 24 to 56GBd Ethernet applications using PAM4 modulation.

[Contact Us](#)



Silicon Photonics vs. EML Technology: Optimizing 1.6T

Compare Silicon Photonics and EML technologies in optical transceivers. Explore the unique advantages of SiPh and EML chip solutions in

[Contact Us](#)

Single Fiber Bidirectional SFP Transceivers

Single Fiber Bidirectional SFP transceivers use simplex single-mode fiber to double the bandwidth, data rates up to 4G and distances up to 160km.

[Contact Us](#)



QSFP28 BiDi TX: 1330nm 10km LC SINGLE RATE 100GbE Single

The QSFP28 100GBase-BX module is designed for data transmission using an one singlemode (SM) fiber. It transmits data at speeds of up to 100 Gbps, over distances of up to 10 km.

[Contact Us](#)

The Difference Between Single/Dual Fiber



As fiber optic networks continue to evolve, selecting the right optical transceiver becomes increasingly important. Whether you're designing a short

[Contact Us](#)



Contact Us

For datasheets, pricing, or custom fiber access solutions, please visit:
<https://www.frindel.es>