

# Air-sealed cable trays for civil defense

## Base station energy composition diagram

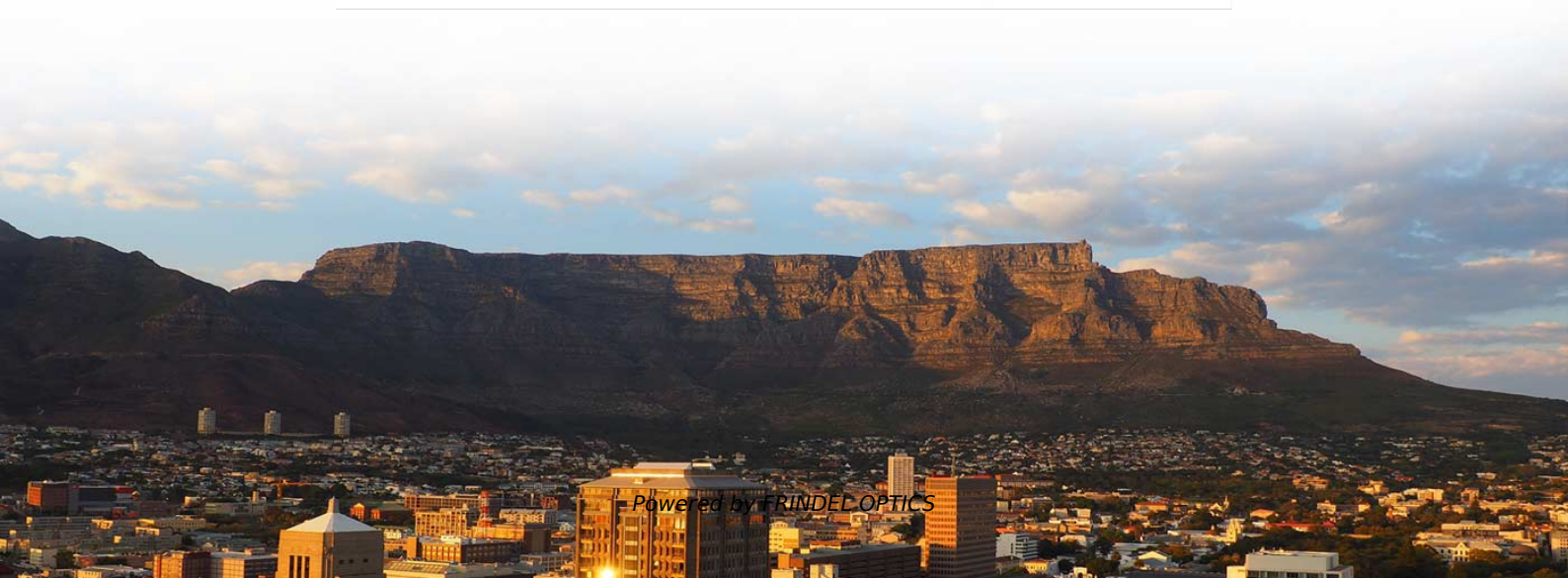

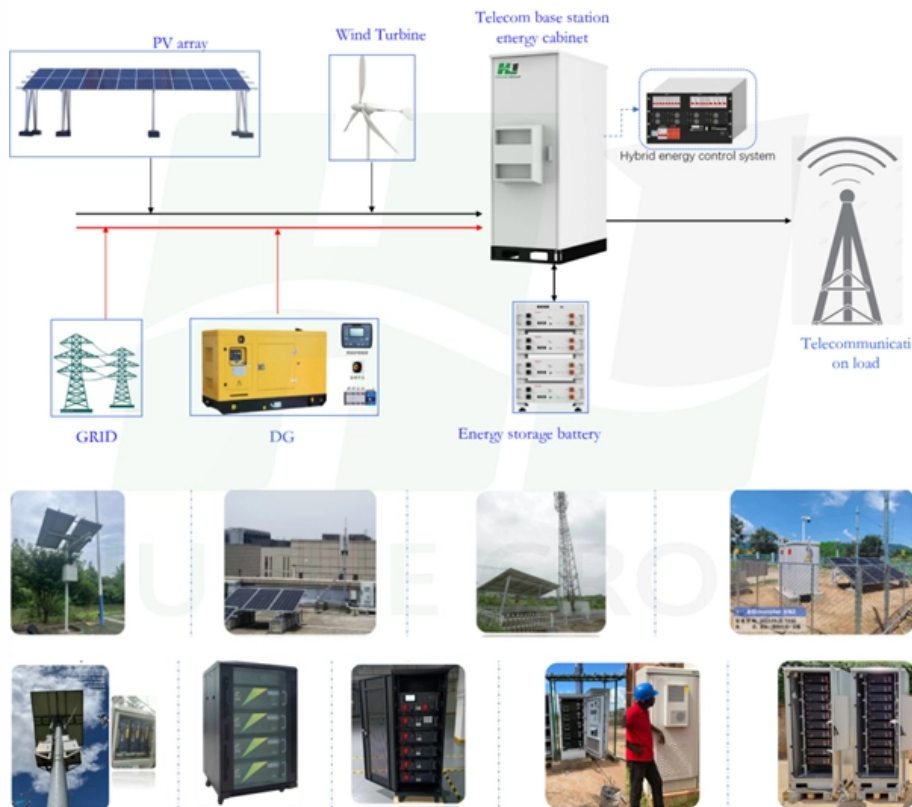

## Air-sealed cable trays for civil defense

---



### **Cable Tray Technical Guide A practical guide to product selection and**

A practical guide to product selection and installation This guide for engineers and installers has been developed by ABB as a practical reference regarding cable tray characteristics, installation, and

[Contact Us](#)

### **Cable Trough , Safe & Secure Cable Protection**

High stability concrete or composite cable trough systems for secure protection of cables and utilities within internal or external surfaces.

[Contact Us](#)

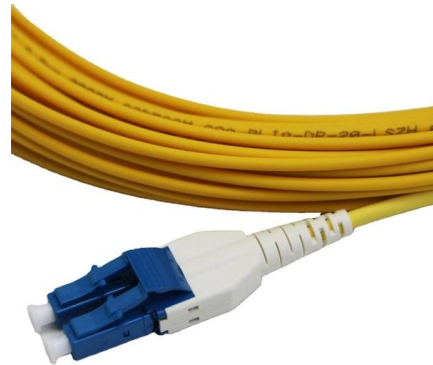

### **Types of Cable Trays - Purpose, Advantages,**

Cable tray is alternatives to wire ways and electrical conduits, which completely enclose cables. Study types of cable trays, purpose, advantages.

[Contact Us](#)



### **Cable tray**

So, whether specifying a major new project, or simply refurbishing existing facilities, choose ABB cable tray to deliver the most effective, reliable and long lasting

[Contact Us](#)

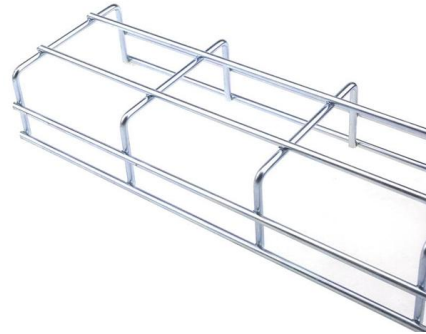

### **Cable trays**

With integral thermal insulation and passive fire protection, Contraflex® provides reliable cable protection from jet fire to 180 minutes and hydrocarbon pool fire

[Contact Us](#)



### **Cable Tray Systems in Ducts, Plenums and Other Air Handling Space**

The objective of this article to provide clear information as to the use of cable tray in those areas covered by Section 300-22 of the 1996 National Electrical Code. Section 318-4 Uses Not

[Contact Us](#)



### **CSD Sealing Systems: Firestops**

CSD FIRSTO® firestops are designed to seal multi-cable and cable tray penetrations of fire-rated walls or floors. FIRSTO® utilizes a metal frame that encompasses

[Contact Us](#)

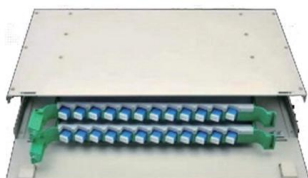



## Ampacity of Power Cables Installed in Cable Trays

Cables installed in trays have lower ampacity than cables installed in free air or on cable ladder supports because the tray restricts airflow to the cables' bottom and

[Contact Us](#)

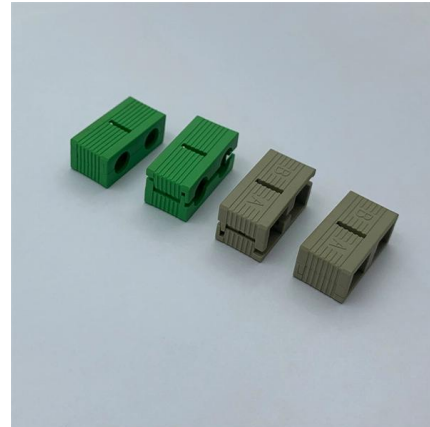

## Cable trays

We offer a wide range of cable tray systems to support tubing, electrical cables and instrumentation. Our cable trays are produced in fit for purpose materials like

[Contact Us](#)

## SECTION 270528 -- CABLE TRAY FOR TELECOMMUNICATIONS

Provide all materials and labor for the installation of a cable tray system for communications infrastructure. This section includes requirements for providing a cable tray system for

[Contact Us](#)



## Cable Trough , Safe & Secure Cable Protection

High stability concrete or composite cable trough systems for secure protection of cables and utilities within internal or external surfaces.

[Contact Us](#)



## Cable Tray Institute

The Cable Tray Institute (CTI) was founded in 1991 to support the cable tray industry by engaging in research, development, education, and the dissemination of

[Contact Us](#)

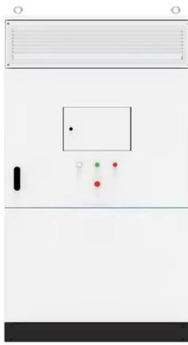

## Microsoft Word

A ladder cable tray without covers permits the maximum free flow of air across the cables. This allows the heat produced in the cable's conductors to effectively dissipate. Under such conditions, the

[Contact Us](#)



## What Are Cable Trays and How Do They Work?

The open nature of many cable tray designs also promotes better air circulation around the cables. Principal Types and Designs Cable trays come in several configurations that balance cable

[Contact Us](#)



Equipped with a removable **Mounting Plate** inside the enclosure, enabling customized drilling and secure component mounting.

## The Complete Guide to Cable Trays , Snake Tray

Learn about the benefits and applications of cable trays, and the specific advantages of using Snake Tray products.

[Contact Us](#)



## Appendix 3F Cable Trays and Cable Tray Supports

This appendix provides the design criteria for seismic Category I cable trays and their supports. Seismic Category II cable trays and their supports are also designed utilizing the design criteria of this appendix.

[Contact Us](#)

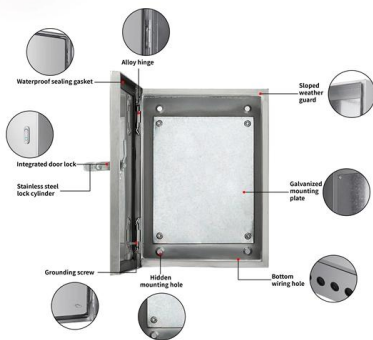
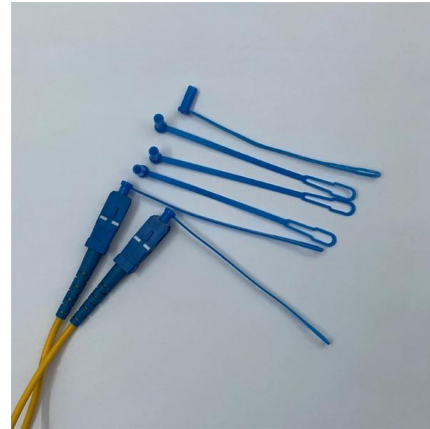

## Space-Tray® Aerial Cable Trays(TM)

Space-Tray is an Aerial Cable Management System, principally intended for smaller-bore cables (up to 36mm dia) in Low Voltage Power and Telecoms applications

[Contact Us](#)

## Electrical Cable Trays for Airport Safety

Conclusion: More than hardware, electrical cable trays for airports serve as a safety net. They defend the airport electrical structure and act as an aviation electrical system fault interceptor.

[Contact Us](#)



## Seismic fragility analysis of suspended cable trays in civil buildings

This study aims to understand the seismic fragility of typical suspended cable trays in civil buildings through full-scale shaking table tests and numerical simulation. Based on the shaking table

[Contact Us](#)

## What Is the Difference Between Cable Tray



When cables aren't routed properly, they can get damaged or cause serious problems. Choosing between a cable tray and a cable trench helps keep

[Contact Us](#)

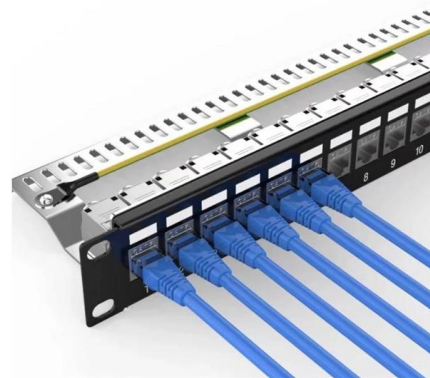

### Cable Management Tray Products

Our cable tray range is available in light, medium and heavy duty, up to and including widths of 900mm. Our easy-fix integrated couplers are simpler, faster and

[Contact Us](#)



### Cable Trays Selection Guide: Types, Features,

Cable trays are components of support systems for power and communications cables and wires. A cable tray system supports and protects both power and

[Contact Us](#)



### Cable tray

In the electrical wiring of buildings, a cable tray system is used to support insulated electrical cables used for power distribution, control, and communication.

[Contact Us](#)



### Fireproof pillow for cable tray penetrations



AF BAGS are intumescent and ablative fireproof pillows certified under EN 1366-3 for sealing up to EI 240 of cable tray penetrations.

[Contact Us](#)



### Types of Cable Containment Systems: Trays, Trunks,

Discover the main types of cable containment systems--trays, trunking, and conduits--and learn how to choose the right solution for safe,

[Contact Us](#)

### Cable transit frames and penetration sealing systems

Seal cable penetrations with our modular firestop solutions, designed to create water-, smoke- and gas-tight barriers in energy and industry projects both onshore and offshore.

[Contact Us](#)



### Containment , Hazardous Area Equipment , Cable Systems

Our range of cable management products for harsh and industrial areas includes cable cleats, cable trays, support systems, and ties, bands and clamps. Together they allow you to run your cables

[Contact Us](#)



## Cable Tray Systems in Ducts, Plenums and Other Air Handling

Cable Tray Systems in Ducts, Plenums and Other Air Handling Space The objective of this article to provide clear information as to the use of cable tray in those areas covered by Section 300-22 of the

[Contact Us](#)

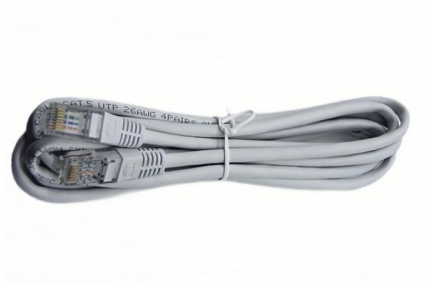

### Cable Tray Systems

Our cable tray systems securely hold and protect cables and come in many models and sizes, solid bottom and ventilated.

[Contact Us](#)

## Contact Us

---

For datasheets, pricing, or custom fiber access solutions, please visit:  
<https://www.frindel.es>