

Afghanistan busbar price





Afghanistan busbar price



Aluminium Flat Busbar Affordable Price for High Performance

Discover our Aluminium Flat Busbar with high conductivity of 60% IACS, lightweight, durable, and corrosion-resistant. Available at the best prices with customizable dimensions up to 6 meters and a

[Contact Us](#)

Busbar Systems , Power Busbars , EAE Electric

Power Busbar Systems are designed for the safe transport and distribution of electrical energy, ranging from 32A to 6300A, ensuring efficiency and reliability.

[Contact Us](#)



Busbar Market Report 2025

The busbar market faces significant challenges due to the sharp rise in copper prices, a key raw material for busbar manufacturing. Copper, known for its

[Contact Us](#)

Aluminium Busbar Market Size, Production, Price, Market Share,

The Aluminium Busbar Price in this region is influenced by North American aluminium premiums and local manufacturing costs, which collectively create a relatively stable but cyclical Aluminium Busbar



Busbar Market Analysis, Size, and Forecast 2025-2029:

The busbar market size is forecast to increase by USD 5.83 billion, at a CAGR of 5.5% between 2024 and 2029. The market is experiencing significant growth due

[Contact Us](#)



Price of Copper Bus Bars

Discover competitive price of copper bus bars, 99.9% pure, CE certified. Ideal for power distribution with custom fabrication and bulk options.

[Contact Us](#)



Busbar Market

Clear representation of competitive analysis of key players by product, price, financial position, product portfolio, growth strategies, and regional presence in the global

[Contact Us](#)





Copper Busbars Manufacturer & Supplier in Saudi Arabia

As a Saudi Arabia supplier, we offer copper busbars in Riyadh, Jeddah & Dammam. Sizes from 10x3mm to 100x10mm. Check types & price of copper bars online.

[Contact Us](#)

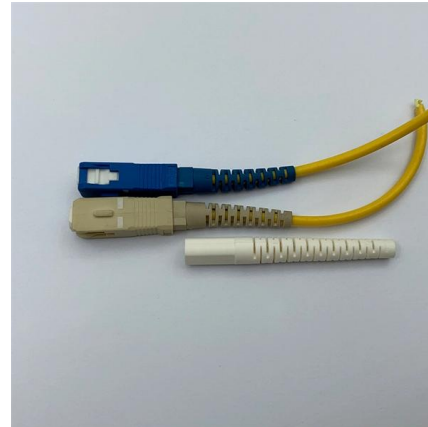

What is the Market Price Range of MCB Busbar

MCB busbars are integral components in electrical power distribution systems, and understanding their market price range is crucial for both buyers

[Contact Us](#)



Schneider Busbar C Curve 3 Pole Price in Pakistan

Buy Schneider Busbar C Curve 3 Pole online from authorized dealers at the best price in Pakistan. Get genuine Schneider Busbar C Curve 3 Pole products at w11stop with free cash on delivery in

[Contact Us](#)

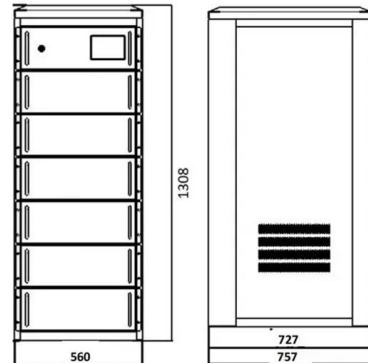

Global Busbar Market Report 2026, Analysis And

Major companies operating in the busbar market are focusing on developing innovation such as modular busbar trunking systems to provide compact, high

[Contact Us](#)



Busbar Market Report 2025

The busbar market faces significant challenges due to the sharp rise in copper prices, a key raw material for busbar manufacturing. Copper, known for its superior electrical conductivity compared with

[Contact Us](#)



Afghanistan Busbar Market (2025-2031) , Trends, Outlook & Forecast

6Wresearch actively monitors the Afghanistan Busbar Market and publishes its comprehensive annual report, highlighting emerging trends, growth drivers, revenue analysis, and forecast outlook.

[Contact Us](#)

Busbars Market Size, Share, Growth, Trends Report 2035

Busbars Market is projected to register a CAGR of 4.81% to reach USD 29597.3 Billion by the end of 2035, Global Busbars Market Conductor, Power Rating, End User, Region , Busbars

[Contact Us](#)

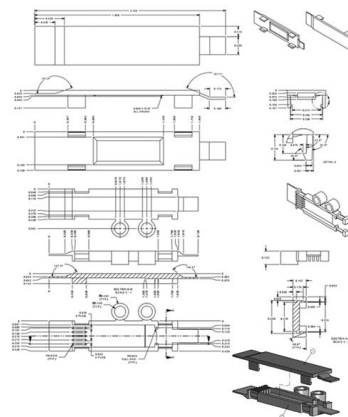

Copper Busbar Price List and Sizes

Copper Busbar Powerflex Price list - Free download as PDF File (.pdf), Text File (.txt) or read online for free. The document is a price list for Rolycab Powerflex, a

[Contact Us](#)



Busbar Market Size to Hit Around USD 29.96 Billion by

The global busbar market size was estimated at USD 19.83 billion in 2026 and is projected to hit around USD 29.96 billion by 2035, with a notable

[Contact Us](#)

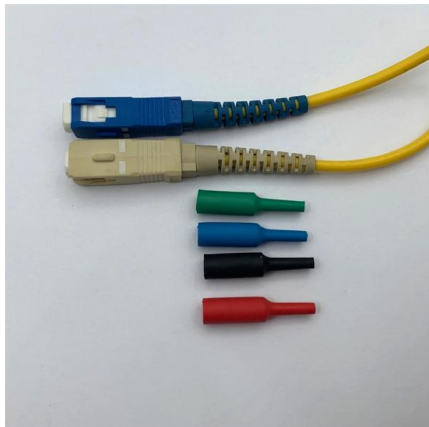
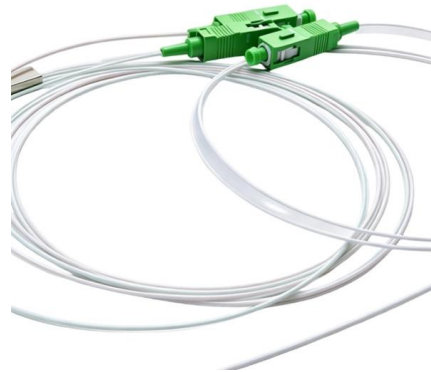

Middle East and Africa Busbar Market

The supply chain analysis section includes detailed insights such as Middle East And Africa Busbar Market consumption and production by country, price trend analysis, the impact of tariffs and

[Contact Us](#)

Best Aluminum Bus Bar Distributors In India

7050 Electrical Aluminium Bus Bar, Flexible Aluminium Busbar, aluminium busbar price per kg, Aluminium 6083 Flat Busbar, Jindal Aluminium Bus Bars, Aluminum

[Contact Us](#)



Copper Bus Bar

Copper Link International's strong network and strategic location make it an ideal partner for businesses looking to source premium copper bus bars with competitive pricing. Copper Link International's

[Contact Us](#)



Busbars , Socomec Middle East, Africa, Northern

Copper busbars and distributors to make power connections within an electrical panel. Flexible conductors, for example, provide a connection between busbars

[Contact Us](#)

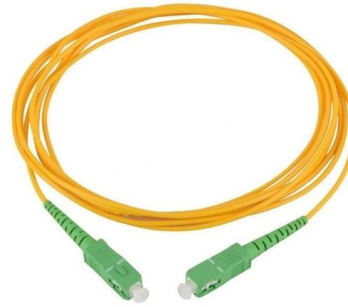

Busbar Market Report: Size, Growth, Trends & Forecast

Busbars Market size was valued at USD 16.65 Billion in 2024 and is projected to reach USD 22.74 Billion by 2032, growing at a CAGR of 4.38% from 2026 to

[Contact Us](#)

Get Aluminium Bus Bar in Afghanistan

Partner with us for unmatched expertise, prompt delivery in Afghanistan, and competitive prices. Choose the Aluminium Bus Bar experts and experience the difference that quality makes in Afghanistan.

[Contact Us](#)



Bus Bar - Coppertech Industries Limited

Electrical Grade Aluminum Bus Bar Specification:
Thickness: 5mm - 12 mm Width: 25mm - 150 mm Length: As per the customer's requirement
Application: We can

[Contact Us](#)



Bus Bar Price

Buy Bus Bar Online from Moglix. Best Bus Bar Brands Online in India Lowest Price Top Quality Bus Bar Box Cash on Delivery

[Contact Us](#)



Busbar Price Guide: Key Factors, Materials & Machine

Busbar price depends on several factors, including material type, busbar size, thickness, current-carrying capacity, cutting requirements, punching

[Contact Us](#)

Busbar Price Guide: Key Factors, Materials & Machine

In this article, I will explain the main reasons behind busbar cost variations, especially when comparing copper busbar, aluminum busbar, and

[Contact Us](#)

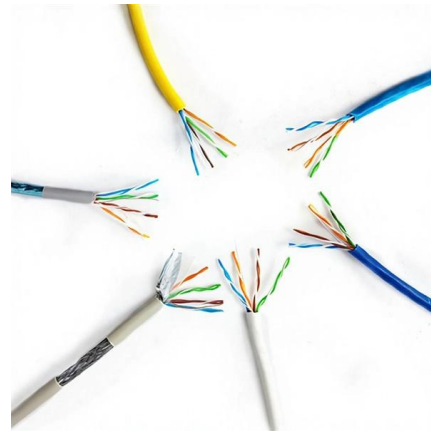

Terminal Blocks and Busbars

Terminal Blocks and Busbars: Push & Pin Type Electronic Terminals, Terminal Strips, Socket Connectors, Steatite Terminal, Electronic Terminals, Transformer

[Contact Us](#)



Busbar Products Pricing Guide: Understanding Costs

This guide offers a detailed busbar pricing guide for electrical contractors, explores what affects pricing, and provides strategies to get the best value busbar

[Contact Us](#)



Busbar Products Pricing Guide: Understanding Costs

Explore our Busbar Products Pricing Guide to budget smarter. Understand cost factors, compare price ranges, and find value-driven tips for copper busbar,

[Contact Us](#)

Contact Us

For datasheets, pricing, or custom fiber access solutions, please visit:
<https://www.frindel.es>